

Product Information: Crawler Excavator

R 956

Litronic®



Generation

6

Engine

250 kW/340 HP

Stage V

Operating Weight

Backhoe: 51,000 – 59,350 kg

Shovel: 56,750 – 57,300 kg

Bucket Capacity

Backhoe: 1.25 – 3.50 m³

Shovel: 2.50 – 3.10 m³

LIEBHERR

Experience the Progress

R 956

Safety

- Panoramic visibility with no obstructions, rear and side view monitoring cameras
- Retractable console for easy and safe access to the cab
- Emergency exit via the rear cab window, whatever the excavator's configuration
- Windshield and right-hand window in laminated tinted glass

Equipment

- Large choice of sticks
- Longer lifespan of components and higher productivity thanks to the automatic centralised lubrication system
- Safety check valves for hoist and stick cylinders

Maintenance

- Maintenance points on the cool side of the engine
- Quick and easy cleaning and visual inspection
- Complementary radiators fitted on hinges
- Engine oil, hydraulic oil, fuel and urea levels visible on the display
- Shut-off valve to quickly and easily interrupt the circulation of oil between the tank and the hydraulic system





Comfort

- Spacious, air-conditioned work space
- Airsprung seat with vertical and longitudinal damping
- Userfriendly high resolution 7" colour touchscreen
- Completely retractable front cab window
- New LED lighting as standard

Engine

- New engine that conforms with the Stage V European exhaust emissions standard
- Automatic engine idling / speed increase, controlled via joystick sensors

Undercarriage

- Robust, reliable X-frame undercarriage, easy to secure thanks to its integrated eyelets
- Easy maintenance
- Maintenance-free crawler track and track rollers with lifetime lubrication
- 3-part chain guide

Experience the Progress

R 956 Shovel

Equipment

- Parallel cinematics for powerful break-out
- Bucket cylinders positioned under the equipment for better protection
- Optional boom cylinder protection

Tools

- Different types of buckets:
- Type I: non-abrasive materials, such as limestone without flint
- Type II: Shot material, or easily breakable rock (classification 3 to 4 according to DIN 18300)
- Type III: Highly abrasive materials, such as rocks with a high silica content, sandstone, granite, etc.





Operator's cab

- Operator's cab with 2' 7" elevation for improved visibility
- Optionally equipped with a FOPS and FGPS front guard
- Comfortable and quiet cab

Technical Data



Engine

Rating per ISO 9249	250 kW (340 HP) at 1,800 RPM
Torque	2,280 Nm at 1,000 RPM
Model	Liebherr D936 A7
Type	6 cylinder in-line
Bore	130 mm
Stroke	150 mm
Displacement	10.5 l
Engine operation	4-stroke diesel Common-Rail, monoturbo
Exhaust gas treatment	Stage V DOC + DPF + SCR Passive regeneration by thermo management
Cooling system	Water-cooled and integrated motor oil cooler, after-cooled and fuel cooled
Air cleaner	Dry-type air cleaner with pre-cleaner, primary and safety elements
Fuel tank	734 l
Urea tank	90 l
Electrical system	
Voltage	24 V
Batteries	2 x 180 Ah/ 12 V
Starter	24 V/7.8 kW
Alternator	Three-phase current 28 V/140 A
Engine idling	Sensor controlled
Motor management	Connection to the integrated excavator system controlling via CAN-BUS to the economical utilisation of the service that is available



Hydraulic Controls

The controlling is conducted via the integrated excavator system technology, input and output modules, communicated via the CAN-BUS with the electronic central unit

Power distribution	Via control valves in single block with integrated safety valves
Flow summation	To boom and stick
Closed-loop circuit	For uppercarriage swing drive
Servo circuit	
Equipment and swing	Proportional via joystick levers
Travel	– Proportional control via foot pedals or removable levers – Speed pre-selection
Additional functions	Proportional regulation via foot pedals or mini-joystick



Hydraulic System

Hydraulic pumps	
For equipment and travel drive	Liebherr, variable displacement, swashplate double pump
Max. flow	2 x 380 l/min.
Max. pressure	350 bar
For swing drive	Reversible, variable displacement, swashplate pump, closed-loop circuit
Max. flow	201 l/min.
Max. pressure	375 bar
Pump regulation	Electro-hydraulic with electronic engine speed sensing regulation, pressure compensation, flow compensation
Hydraulic tank	380 l
Hydraulic system	743 l
Hydraulic oil filter	2 full flow filters in return line with integrated fine filter area (5 µm)
Cooling system	Compact cooler for water cooler, after-cooler, fuel cooler and transmission pump oil, sandwiched with cooler for oil and condenser of air-conditioning with hydrostatically controlled fan drives
MODE selection	Adjustment of engine and hydraulic performance via a mode pre-selector to match application, e.g. for especially economical and environmentally friendly operation or for maximum digging performance and heavy-duty jobs
RPM adjustment	Stepless adjustment of engine output via RPM at each selected mode
Tool Control	20 preadjustable pump flows and pressures for add-on attachments



Swing Drive

Drive	Liebherr swashplate motor with integrated brake valve
Transmission	Liebherr compact planetary reduction gears
Swing ring	Liebherr, sealed race ball bearing swing ring, internal teeth
Swing speed	0 – 5.8 RPM stepless
Swing torque	160 kNm
Holding brake	Wet multi-disc (spring applied, pressure released)



Operator's Cab

Cab	LED work headlights integrated in the ceiling, a door with a sliding window (can be opened on both sides), large storing box and several stowing possibilities, shock-absorbing suspension, sounddamping insulating, tinted laminated safety glass, separate window shades for the sunroof window and windscreen, cigarette lighter and 12 V plug, storage bins, lunchbox, cup holder
Operator's seat	Liebherr-Comfort seat, airsprung with automatic weight adjustment, vertical and longitudinal seat damping including consoles and joysticks. Seat and armrests adjustable separately and in combination (adjustable in width, height and inclination), seat heating as standard
Arm consoles	Oscillating consoles with seat, tiltable console left
Operation and displays	Large high-resolution operating unit, intuitive, colour display with touchscreen, video-compatible, numerous setting, control and monitoring options, e.g. air conditioning control, fuel consumption, machine and attachment parameters
Air-conditioning	Automatic air-conditioning, recirculated air function, fast de-icing and demisting at the press of a button, air vents can be operated via a menu. Recirculated air and fresh air filters can be easily replaced and are accessible from the outside. Heating-cooling unit, designed for extreme outside temperatures, sensors for solar radiation, inside and outside temperatures The air conditioning system contains fluorinated greenhouse gases
Refrigerant	R134a
Global warming potential	1,430
Quantity at 25 °C*	1,260 g
CO ₂ equivalent	1.80 t
Vibration emission**	
Hand/arm vibrations	< 2.5 m/s ² , according with ISO 5349-1:2001
Whole-body vibrations	< 0.5 m/s ²
Measuring inaccuracy	According with standard EN 12096:1997
Noise emission	
ISO 6396	L _{PA} (inside cab) = 72 dB(A)
2000/14/EC	L _{WA} (surround noise) = 106 dB(A)

Undercarriage

Versions	
LC	Gauge 2,900 mm
LC-V	Gauge 2,890 mm
HD	Gauge 2,900 mm
Drive	Liebherr swashplate motor with integrated brake valve
Transmission	Liebherr compact planetary reduction gear
Maximum travel speed	LC: low range 3.3 km/h high range 4.8 km/h LC-V/HD: low range 2.6 km/h high range 3.7 km/h
Drawbar pull on crawler	LC: 377 kN LC-V/HD: 446 kN
Track components	LC: D7G, maintenance-free LC-V/HD: D8L, maintenance-free
Track rollers/ Carrier rollers	LC: 10/2 LC-V: 10/3 HD: 9/2
Tracks	Sealed and greased
Track pads	Triple grouser
Holding brake	Wet multi-disc (spring applied, pressure released)
Brake valves	Integrated into travel motor
Lashing eyes	Integrated



Equipment

Type	Combination of resistant steel plates and cast steel components
Hydraulic cylinders	Liebherr cylinders with seal and guidance systems
Bearings	Sealed, low maintenance
Lubrication	Automatic central lubrication system (except link and tilt geometry)
Hydraulic connections	Pipes and hoses equipped with SAE split-flange connections
Buckets	Standard equipped with Liebherr tooth system

* Valid for standard machine without operator's cab elevation and without height adjustable cab

** For the risk assessment according to 2002/44/EC see ISO/TR 25398:2006

Dimensions

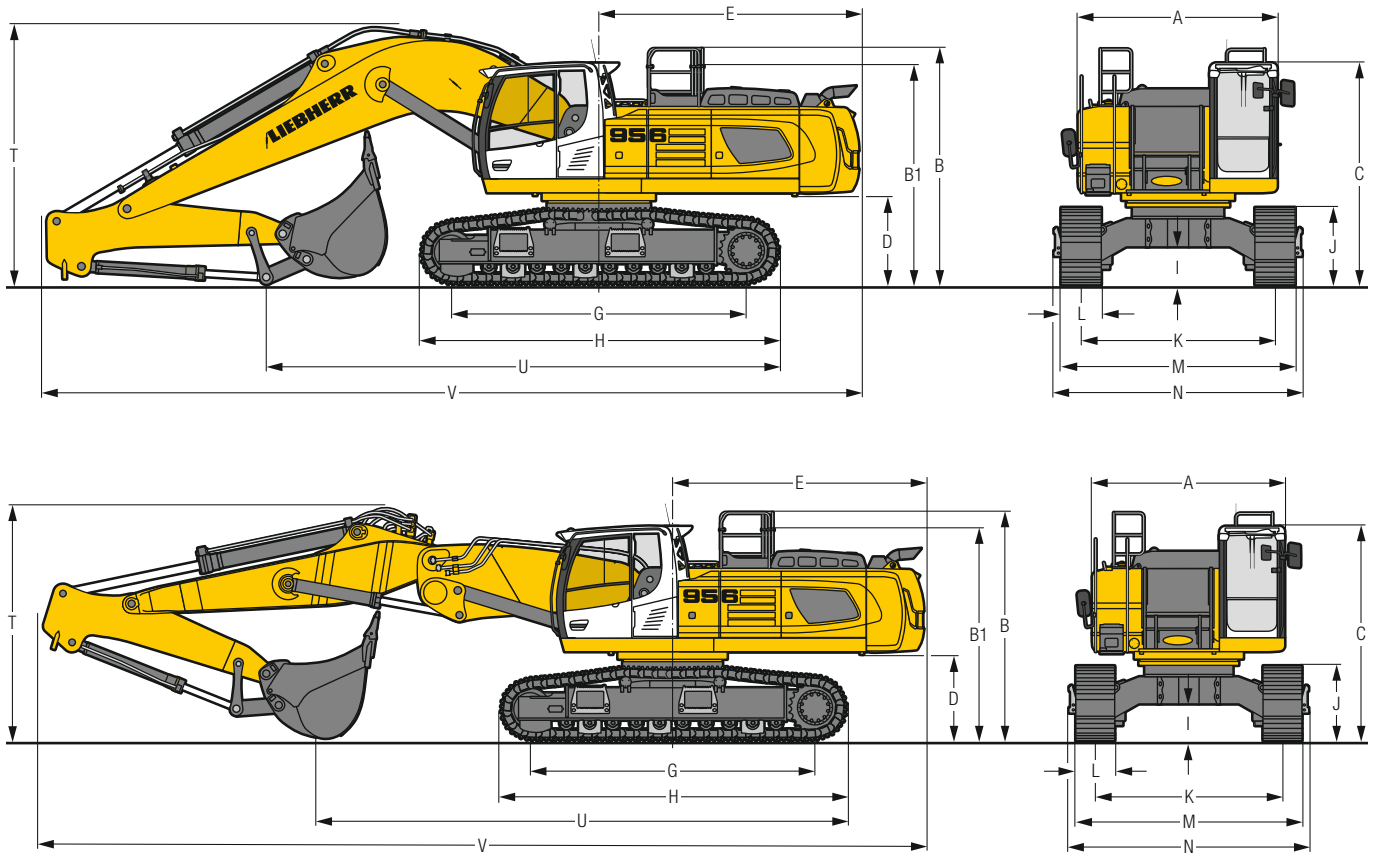

	LC	mm			HD	mm			LC-V	mm		
A* Uppercarriage width		2,970				2,970				2,970		
B Uppercarriage height		3,535				3,555				3,660		
B1 Uppercarriage height (handrails folded)		3,285				3,305				3,410		
C Cab height		3,315/3,510***				3,335/3,530***				3,440/3,635***		
D Counterweight ground clearance		1,335				1,355				1,460		
E Rear-end length		3,900				3,900				3,900		
G Wheelbase		4,400				4,500				4,500		
H Undercarriage length		5,365				5,550				5,550		
I Undercarriage ground clearance		555				575				800		
J Track height		1,160				1,225				1,210		
K Track gauge		2,900				2,900				2,390/2,890**		
L Track pad width		500	600	750		500	600	750		500	600	750
M Width over tracks		3,465	3,500	3,650		3,465	3,500	3,650		2,970/3,470**	2,990/3,490**	3,140/3,640**
N Width over steps		3,715	3,715	3,715		3,715	3,715	3,715		3,225/3,725**	3,225/3,725**	3,225/3,725**

* without door stop device and spacer

** work position

*** with FOPS top guard

	Stick length m	Mono boom 6.70 m direct mounting			Mono boom 7.60 m direct mounting			Mono boom straight 8.00 m direct mounting			Two-piece boom 7.90 m direct mounting			Mono boom 9.20 m direct mounting		
		LC	HD	LC-V	LC	HD	LC-V	mm	HD	mm	LC	HD	LC-V	LC	mm	LC-V
T Boom height	2.35	3,900	3,900	4,000	3,900	3,900	4,000	3,600	3,650	3,650	3,700	–	–	–	–	–
	2.90	3,950	3,950	4,050	3,950	3,950	4,050	3,700	3,750	3,750	3,800	4,150	4,250	–	–	–
	3.80	3,900*	3,900*	4,000*	4,000	4,000	4,100	3,850	4,050	4,000	4,050	4,250	4,350	–	–	–
	5.00	–	–	–	–	–	–	–	–	–	–	4,350	4,450	–	–	–
U Length on ground	2.35	7,650	7,750	7,750	7,600	7,700	7,700	8,350	8,200	8,050	8,150	–	–	–	–	–
	2.90	7,100	7,200	7,200	8,200	8,300	8,300	7,900	7,600	7,600	7,700	8,750	8,900	–	–	–
	3.80	9,300*	9,400*	9,400*	7,300	7,400	7,400	8,250	7,000	6,900	7,100	9,000	9,150	–	–	–
	5.00	–	–	–	–	–	–	–	–	–	–	7,750	7,900	–	–	–
V Overall length	2.35	12,200			13,250			13,800			13,700			14,900		
	2.90	12,250			13,250			13,700			13,600			14,900		
	3.80	12,200*			13,250			13,700			13,600			14,900		
	5.00	–			–			–			–			–		
Bucket		2.70 m ³			2.00 m ³			2.00 m ³			2.00 m ³			1.65 m ³		

* without bucket

Transport Dimensions

removable elements disassembled

	Undercarriage / Stick mm	Mono boom 6.70 m			Mono boom 7.60 m			Mono boom straight 8.00 m			Two-piece boom 7.90 m			Mono boom 9.20 m		
		mm	mm	mm	mm	mm	mm	mm	mm	mm	mm	mm	mm	mm	mm	
Pad width	LC	500	600	750	500	600	750	500	600	750	500	600	750	500	600	750
	HD	3,715	3,715	3,715	3,715	3,715	3,715	3,715	3,715	3,715	3,715	3,715	3,715	3,715	3,715	3,715
	LC-V	3,225	3,225	3,225	3,225	3,225	3,225	–	–	–	3,225	3,225	3,225	3,225	3,225	3,225
Transport width	LC	3,715	3,715	3,715	3,715	3,715	3,715	3,715	3,715	3,715	3,715	3,715	3,715	3,715	3,715	3,715
	HD	3,715	3,715	3,715	3,715	3,715	3,715	3,715	3,715	3,715	3,715	3,715	3,715	3,715	3,715	3,715
	LC-V	3,225	3,225	3,225	3,225	3,225	3,225	–	–	–	3,225	3,225	3,225	3,225	3,225	3,225
	LC	3,225	3,225	3,225	3,225	3,225	3,225	–	–	–	3,225	3,225	3,225	3,225	3,225	3,225
Transport length	2.35	12,200			13,250			13,800			13,700			14,900		
	2.90	12,250			13,250			13,700			13,600			14,900		
	3.80	12,200*			13,250			13,700			13,600			14,900		
	5.00	–			–			–			–			14,900		
Transport height	2.35	3,900	3,900	4,000	3,900	3,900	4,000	3,600	3,650	3,650	3,700	–	–	–	–	–
	2.90	3,950	3,950	4,050	3,950	3,950	4,050	3,700	3,750	3,750	3,800	4,150	4,250	–	–	–
	3.80	3,900	3,900	4,000	4,000	4,000	4,100	3,850	4,050	4,050	4,050	4,250	4,350	–	–	–
	5.00	–	–	–	–	–	–	–	–	–	–	4,350	4,450	–	–	–
Bucket		2.70 m ³			2.00 m ³			2.00 m ³			2.00 m ³			1.65 m ³		

* without bucket

Backhoe Bucket

with Mono Boom 6.70 m and Counterweight 9.0 t

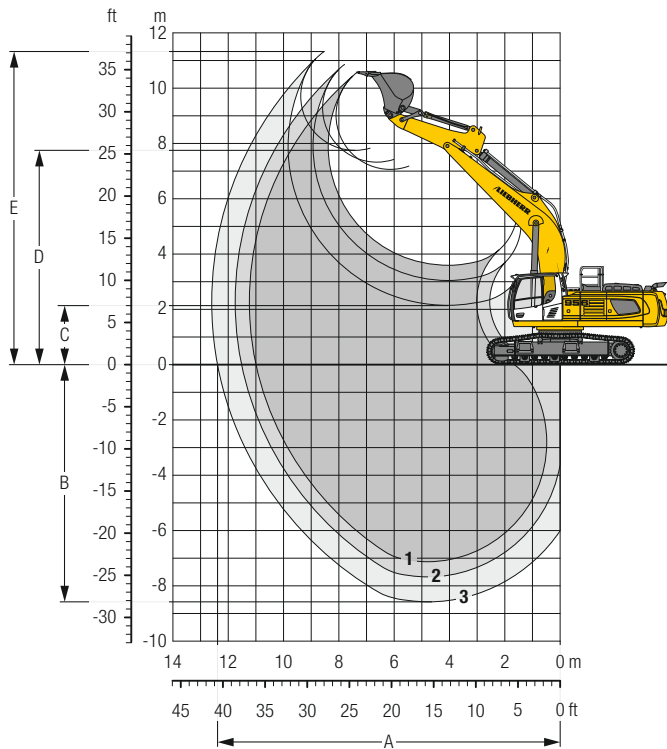

Digging Envelope

without quick coupler		1	2	3
Stick length	m	2.35	2.90	3.80
A Max. reach at ground level	m	11.10	11.50	12.40
B Max. digging depth	m	7.15	7.70	8.60
C Min. dumping height	m	3.60	3.05	3.15
D Max. dumping height	m	7.05	7.30	7.70
E Max. cutting height	m	10.55	10.85	11.30

Forces

without quick coupler		1	2	3
Stick digging force (ISO 6015)	kN	249	218	182
Bucket digging force (ISO 6015)	kN	316	316	316
Stick digging force (SAE J1179)	kN	235	207	174
Bucket digging force (SAE J1179)	kN	273	273	273

Max. bucket digging force ISO with ripper bucket

345 kN

Operating Weight and Ground Pressure

The operating weight includes the basic machine with counterweight 9.0 t, mono boom 6.70 m, stick 2.90 m and HD bucket 2.70 m³ (3,100 kg).

Undercarriage		LC			HD		
		500	600	750	500	600	750
Pad width	mm	500	600	750	500	600	750
Weight	kg	51,400	52,000	53,250	53,500	54,050	54,850
Ground pressure	kg/cm ²	1.09	0.92	0.75	1.10	0.93	0.75

Undercarriage		LC-V		
		500	600	750
Pad width	mm	500	600	750
Weight	kg	56,050	56,600	57,400
Ground pressure	kg/cm ²	1.15	0.97	0.79

Optional: counterweight 11.0 t

(counterweight 11.0 t increases the operating weight by 2,000 kg and ground pressure by 0.04 kg/cm²) see load tables on page 23

Buckets Machine stability per ISO 10567* (75% of tipping capacity)

	Cutting width mm	Capacity ISO 7451 m ³	Weight kg	LC-Undercarriage (with track pads 600 mm)			LC-V-Undercarriage (with track pads 600 mm)			HD-Undercarriage (with track pads 600 mm)		
				Stick length (m)			Stick length (m)			Stick length (m)		
				2.35	2.90	3.80	2.35	2.90	3.80	2.35	2.90	3.80
with counterweight 9.0 t												
STD ¹⁾	1,550	2.00	2,250	▲	▲	▲	▲	▲	▲	▲	▲	▲
	1,750	2.35	2,450	▲	▲	▲	▲	▲	▲	▲	▲	▲
	1,950	2.70	2,650	▲	■	△	▲	▲	△	▲	▲	△
	1,950	3.00	2,750	■	▲	△	▲	■	△	▲	■	△
	2,100	3.30	2,850	▲	■	-	▲	▲	-	■	▲	-
HD ²⁾	1,550	2.00	2,650	▲	▲	▲	▲	▲	▲	▲	▲	▲
	1,750	2.35	2,850	▲	▲	■	▲	▲	■	▲	▲	■
	1,950	2.70	3,100	▲	■	△	▲	▲	△	▲	■	△
	1,950	3.00	3,200	■	■	-	▲	■	-	■	▲	-
	1,950	3.30	3,250	▲	△	-	■	▲	-	▲	■	-
2,100	3.50	3,500	■	△	-	▲	■	-	■	△	-	
with counterweight 11,0 t												
STD ¹⁾	1,550	2.00	2,250	▲	▲	▲	▲	▲	▲	▲	▲	▲
	1,750	2.35	2,450	▲	▲	▲	▲	▲	▲	▲	▲	▲
	1,950	2.70	2,650	▲	▲	△	▲	▲	△	▲	▲	△
	1,950	3.00	2,750	▲	▲	△	▲	▲	△	▲	▲	△
	2,100	3.30	2,850	▲	■	-	▲	▲	-	▲	■	-
HD ²⁾	1,550	2.00	2,650	▲	▲	▲	▲	▲	▲	▲	▲	▲
	1,750	2.35	2,850	▲	▲	■	▲	▲	■	▲	▲	■
	1,950	2.70	3,100	▲	▲	△	▲	▲	△	▲	▲	△
	1,950	3.00	3,200	▲	■	-	▲	▲	-	▲	▲	-
	1,950	3.30	3,250	▲	■	-	▲	▲	-	▲	■	-
2,100	3.50	3,500	■	▲	-	▲	■	-	■	▲	-	

* Indicated loads are based on ISO 10567, at maximum reach, and may be swung 360° on firm and even ground

¹⁾ Standard bucket with Liebherr teeth Z 70 (appropriate for materials up to classification 5, according to VOB, Section C, DIN 18300)

²⁾ HD bucket with Liebherr teeth Z 70 (appropriate for materials above classification 6, according to VOB, Section C, DIN 18300)

Other buckets available upon request

Max. material weight ▲ = ≤ 2.0 t/m³, ■ = ≤ 1.8 t/m³, ▲ = ≤ 1.65 t/m³, ■ = ≤ 1.5 t/m³, △ = ≤ 1.2 t/m³, - = not authorised

Backhoe Bucket

with Mono Boom 7.60 m and Counterweight 9.0 t

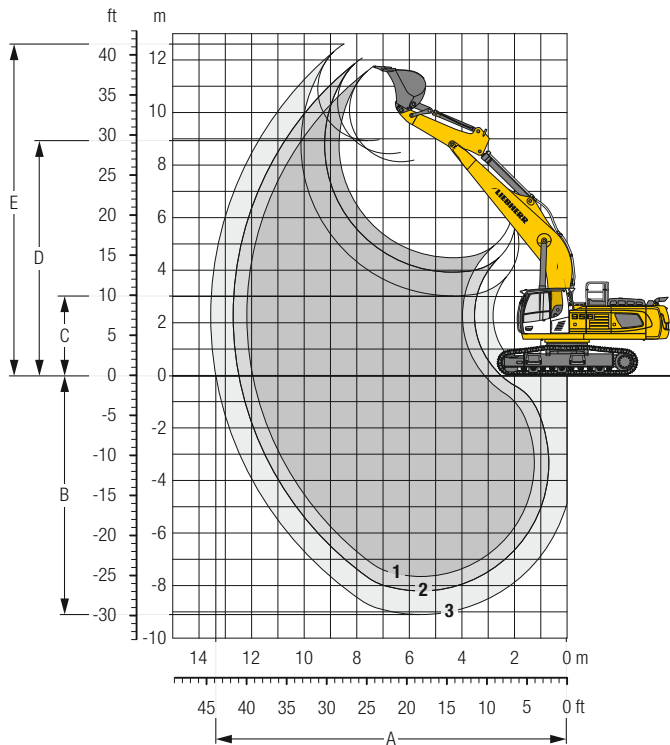

Digging Envelope

without quick coupler		1	2	3
Stick length	m	2.35	2.90	3.80
A Max. reach at ground level	m	11.95	12.50	13.35
B Max. digging depth	m	7.65	8.20	9.10
C Min. dumping height	m	4.45	3.90	3.00
D Max. dumping height	m	8.10	8.40	8.90
E Max. cutting height	m	11.70	12.05	12.60

Forces

without quick coupler		1	2	3
Stick digging force (ISO 6015)	kN	249	218	182
Bucket digging force (ISO 6015)	kN	316	316	316
Stick digging force (SAE J1179)	kN	235	207	174
Bucket digging force (SAE J1179)	kN	273	273	273

Max. bucket digging force ISO with ripper bucket

345 kN

Operating Weight and Ground Pressure

The operating weight includes the basic machine with counterweight 9.0 t, mono boom 7.60 m, stick 2.90 m and bucket 2.00 m³ (2,250 kg).

Undercarriage		LC			HD		
		500	600	750	500	600	750
Pad width	mm	500	600	750	500	600	750
Weight	kg	51,000	51,600	52,850	53,100	53,650	54,450
Ground pressure	kg/cm ²	1.08	0.91	0.74	1.09	0.92	0.74

Undercarriage		LC-V		
		500	600	750
Pad width	mm	500	600	750
Weight	kg	55,650	56,200	57,000
Ground pressure	kg/cm ²	1.14	0.96	0.78

Optional: counterweight 11.0 t

(counterweight 11.0 t increases the operating weight by 2,000 kg and ground pressure by 0.04 kg/cm²) see load tables on page 25

Buckets Machine stability per ISO 10567* (75% of tipping capacity)

	Cutting width mm	Capacity ISO 7451 m ³	Weight kg	LC-Undercarriage (with track pads 600 mm)			LC-V-Undercarriage (with track pads 600 mm)			HD-Undercarriage (with track pads 600 mm)		
				Stick length (m)			Stick length (m)			Stick length (m)		
				2.35	2.90	3.80	2.35	2.90	3.80	2.35	2.90	3.80
with counterweight 9.0 t												
STD ¹⁾	1,550	2.00	2,250	▲	▲	▲	▲	▲	▲	▲	■	
	1,750	2.35	2,450	■	▲	△	▲	▲	▲	■	■	
	1,950	2.70	2,650	▲	△	–	■	▲	△	▲	△	
	1,950	3.00	2,750	△	△	–	▲	△	△	■	–	
	2,100	3.30	2,850	△	–	–	■	△	–	△	△	
HD ²⁾	1,550	2.00	2,650	▲	■	■	▲	▲	■	▲	▲	
	1,750	2.35	2,850	■	■	△	▲	■	■	▲	△	
	1,950	2.70	3,100	■	△	–	▲	■	△	■	–	
	1,950	3.00	3,200	△	–	–	■	△	–	△	△	
with counterweight 11.0 t												
STD ¹⁾	1,550	2.00	2,250	▲	▲	▲	▲	▲	▲	▲	▲	
	1,750	2.35	2,450	▲	▲	▲	▲	▲	▲	▲	▲	
	1,950	2.70	2,650	■	▲	△	▲	▲	△	▲	△	
	1,950	3.00	2,750	▲	■	△	■	▲	△	■	△	
	2,100	3.30	2,850	■	△	–	▲	■	–	▲	△	
HD ²⁾	1,550	2.00	2,650	▲	▲	■	▲	▲	■	▲	■	
	1,750	2.35	2,850	▲	■	■	▲	▲	■	▲	■	
	1,950	2.70	3,100	■	■	△	▲	■	△	■	△	
	1,950	3.00	3,200	▲	△	–	■	▲	–	▲	–	

* Indicated loads are based on ISO 10567, at maximum reach, and may be swung 360° on firm and even ground

¹⁾ Standard bucket with Liebherr teeth Z 70 (appropriate for materials up to classification 5, according to VOB, Section C, DIN 18300)

²⁾ HD bucket with Liebherr teeth Z 70 (appropriate for materials above classification 6, according to VOB, Section C, DIN 18300)

Other buckets available upon request

Max. material weight ▲ = ≤ 2.0 t/m³, ■ = ≤ 1.8 t/m³, ▲ = ≤ 1.65 t/m³, ■ = ≤ 1.5 t/m³, △ = ≤ 1.2 t/m³, – = not authorised

Backhoe Bucket

with Mono Boom Straight 8.00 m and Counterweight 9.0 t

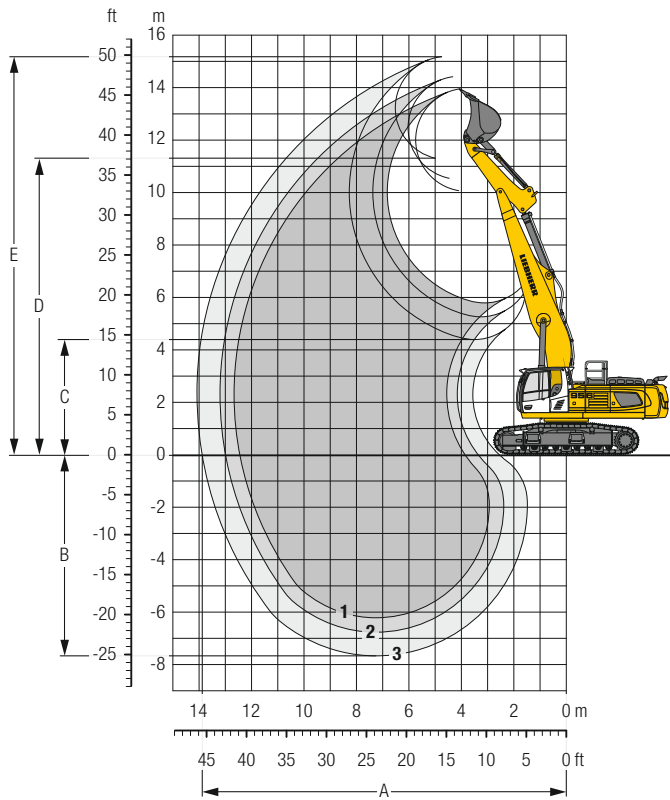

Digging Envelope

without quick coupler		1	2	3
Stick length	m	2.35	2.90	3.80
A Max. reach at ground level	m	12.45	13.00	13.90
B Max. digging depth	m	6.20	6.75	7.65
C Min. dumping height	m	5.80	5.25	4.40
D Max. dumping height	m	10.05	10.55	12.30
E Max. cutting height	m	13.95	14.40	15.20

Forces

without quick coupler		1	2	3
Stick digging force (ISO 6015)	kN	249	218	182
Bucket digging force (ISO 6015)	kN	316	316	316
Stick digging force (SAE J1179)	kN	235	207	174
Bucket digging force (SAE J1179)	kN	273	273	273

Max. bucket digging force ISO with ripper bucket

345 kN

Operating Weight and Ground Pressure

The operating weight includes the basic machine with counterweight 9.0 t, mono boom straight 8.00 m, stick 2.90 m and bucket 2.00 m³ (2,250 kg).

Undercarriage		HD		
Pad width	mm	500	600	750
Weight	kg	53,150	53,700	54,500
Ground pressure	kg/cm ²	1.09	0.92	0.74

Optional: counterweight 11.0 t

(counterweight 11.0 t increases the operating weight by 2,000 kg and ground pressure by 0.04 kg/cm²) see load tables on page 27

Buckets Machine stability per ISO 10567* (75% of tipping capacity)

	Cutting width mm	Capacity ISO 7451 m ³	Weight kg	HD-Undercarriage (with track pads 600 mm)		
				Stick length (m)		
				2.35	2.90	3.80
with counterweight 9.0 t						
STD ¹⁾	1,350	1.65	2,100	▲	▲	■
	1,550	2.00	2,250	▲	■	■
	1,750	2.35	2,450	■	■	△
	1,950	2.70	2,650	■	△	-
HD ²⁾	1,350	1.65	2,350	▲	▲	■
	1,550	2.00	2,650	▲	▲	△
	1,750	2.35	2,850	▲	△	-
	1,950	2.70	3,100	△	-	-
with counterweight 11.0 t						
STD ¹⁾	1,350	1.65	2,100	▲	▲	▲
	1,550	2.00	2,250	▲	▲	■
	1,750	2.35	2,450	▲	■	■
	1,950	2.70	2,650	■	■	△
HD ²⁾	1,350	1.65	2,350	▲	▲	▲
	1,550	2.00	2,650	▲	▲	▲
	1,750	2.35	2,850	▲	▲	△
	1,950	2.70	3,100	▲	△	△

* Indicated loads are based on ISO 10567, at maximum reach, and may be swung 360° on firm and even ground

¹⁾ Standard bucket with Liebherr teeth Z 70 (appropriate for materials up to classification 5, according to VOB, Section C, DIN 18300)

²⁾ HD bucket with Liebherr teeth Z 70 (appropriate for materials above classification 6, according to VOB, Section C, DIN 18300)

Other buckets available upon request

Max. material weight ▲ = ≤ 2.0 t/m³, ■ = ≤ 1.8 t/m³, ▲ = ≤ 1.65 t/m³, ■ = ≤ 1.5 t/m³, △ = ≤ 1.2 t/m³, - = not authorised

Backhoe Bucket

with Two-Piece Boom 7.90 m (Main Boom 4.70 m) and Counterweight 9.0 t

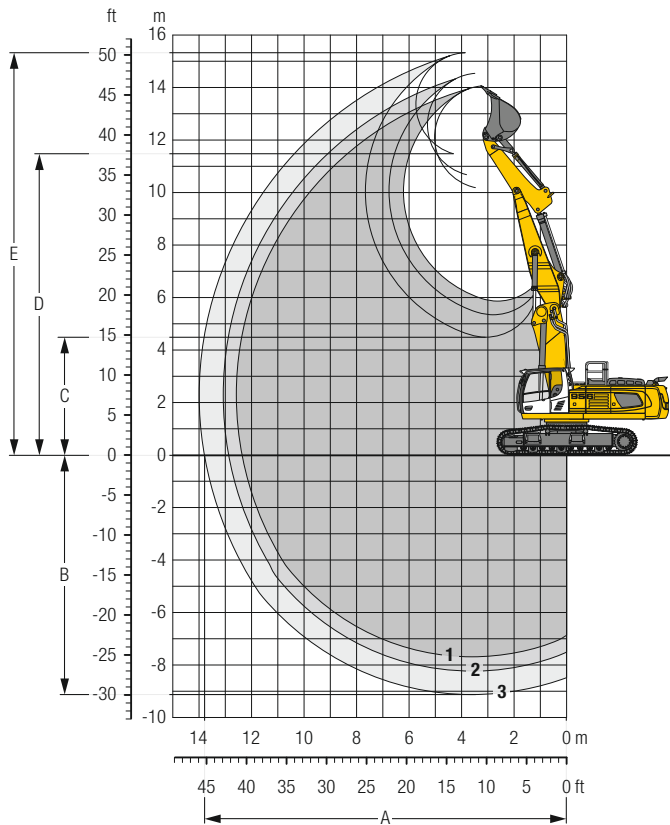

Digging Envelope

without quick coupler		1	2	3
Stick length	m	2.35	2.90	3.80
A Max. reach at ground level	m	12.35	12.90	13.80
B Max. digging depth	m	7.70	8.25	9.15
C Min. dumping height	m	5.85	5.35	4.50
D Max. dumping height	m	10.15	10.65	11.45
E Max. cutting height	m	14.05	14.50	15.30

Forces

without quick coupler		1	2	3
Stick digging force (ISO 6015)	kN	249	218	182
Bucket digging force (ISO 6015)	kN	316	316	316
Stick digging force (SAE J1179)	kN	235	207	174
Bucket digging force (SAE J1179)	kN	273	273	273

Max. bucket digging force ISO with ripper bucket

345 kN

Operating Weight and Ground Pressure

The operating weight includes the basic machine with counterweight 9.0 t, two-piece boom 7.90 m, stick 2.90 m and bucket 2.00 m³ (2,250 kg).

Undercarriage		LC			HD		
Pad width	mm	500	600	750	500	600	750
Weight	kg	54,200	54,800	56,050	56,300	56,850	57,650
Ground pressure	kg/cm ²	1.14	0.96	0.79	1.16	0.97	0.79

Undercarriage		LC-V		
Pad width	mm	500	600	750
Weight	kg	58,850	59,400	60,200
Ground pressure	kg/cm ²	1.21	1.02	0.83

Optional: counterweight 11.0 t

(counterweight 11.0 t increases the operating weight by 2,000 kg and ground pressure by 0.04 kg/cm²) see load tables on pages 30 and 31

Buckets Machine stability per ISO 10567* (75% of tipping capacity)

	Cutting width mm	Capacity ISO 7451 m ³	Weight kg	LC-Undercarriage (with track pads 600 mm)			LC-V-Undercarriage (with track pads 600 mm)			HD-Undercarriage (with track pads 600 mm)		
				Stick length (m)			Stick length (m)			Stick length (m)		
				2.35	2.90	3.80	2.35	2.90	3.80	2.35	2.90	3.80
with counterweight 9.0 t												
STD ¹⁾	1,350	1.65	2,100	▲	■	■	▲	▲	■	▲	▲	▲
	1,550	2.00	2,250	▲	■	△	▲	■	■	■	▲	△
	1,750	2.35	2,450	△	△	-	▲	■	△	■	△	-
	1,950	2.70	2,650	△	-	-	▲	△	-	△	-	-
HD ²⁾	1,350	1.65	2,350	▲	■	△	▲	▲	▲	▲	▲	■
	1,550	2.00	2,650	■	△	-	■	▲	△	■	■	△
	1,750	2.35	2,850	△	-	-	■	△	-	△	△	-
with counterweight 11.0 t												
STD ¹⁾	1,350	1.65	2,100	▲	▲	▲	▲	▲	▲	▲	▲	▲
	1,550	2.00	2,250	▲	■	■	▲	▲	■	▲	▲	▲
	1,750	2.35	2,450	■	■	△	▲	■	■	■	▲	△
	1,950	2.70	2,650	■	△	-	▲	■	△	▲	△	-
	1,950	3.00	2,750	△	-	-	■	△	-	△	△	-
HD ²⁾	1,350	1.65	2,350	▲	▲	■	▲	▲	▲	▲	▲	▲
	1,550	2.00	2,650	▲	■	△	▲	▲	▲	▲	■	■
	1,750	2.35	2,850	▲	△	-	■	▲	△	■	■	△
	1,950	2.70	3,100	△	△	-	▲	△	-	■	△	-

* Indicated loads are based on ISO 10567, at maximum reach, and may be swung 360° on firm and even ground

¹⁾ Standard bucket with Liebherr teeth Z 70 (appropriate for materials up to classification 5, according to VOB, Section C, DIN 18300)

²⁾ HD bucket with Liebherr teeth Z 70 (appropriate for materials above classification 6, according to VOB, Section C, DIN 18300)

Other buckets available upon request

Max. material weight ▲ = ≤ 2.0 t/m³, ■ = ≤ 1.8 t/m³, ▲ = ≤ 1.65 t/m³, ■ = ≤ 1.5 t/m³, △ = ≤ 1.2 t/m³, - = not authorised

Backhoe Bucket

with Mono Boom 9.20 m and Counterweight 11.0 t

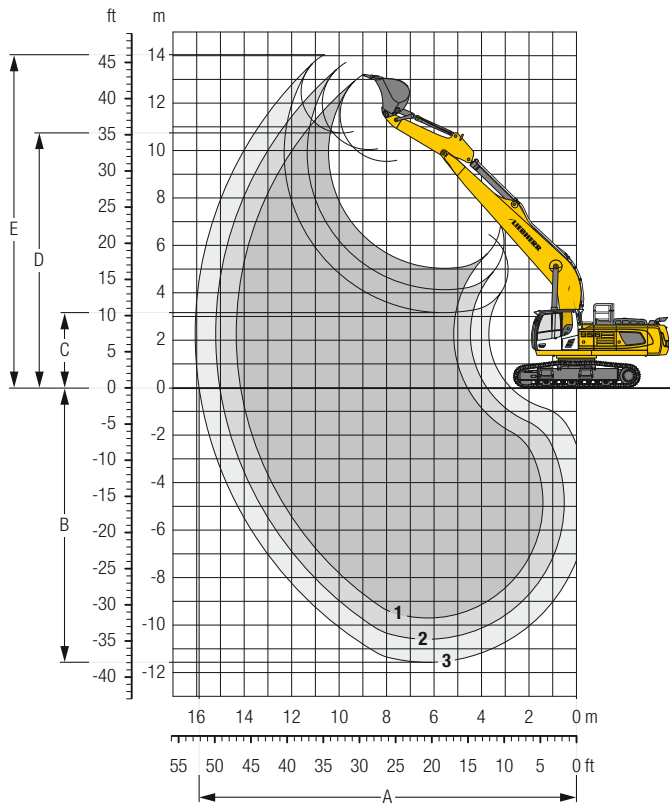

Digging Envelope

without quick coupler		1	2	3*
Stick length	m	2.90	3.80	5.00
A Max. reach at ground level	m	14.10	15.00	15.90
B Max. digging depth	m	9.70	10.60	11.60
C Min. dumping height	m	5.05	4.15	3.15
D Max. dumping height	m	9.55	10.05	10.75
E Max. cutting height	m	13.15	13.70	14.00

Forces

without quick coupler		1	2	3*
Stick digging force (ISO 6015)	kN	218	182	149
Bucket digging force (ISO 6015)	kN	316	316	235
Stick digging force (SAE J1179)	kN	207	174	145
Bucket digging force (SAE J1179)	kN	273	273	209

* with kinematic R 946 Litronic

Operating Weight and Ground Pressure

The operating weight includes the basic machine with counterweight 11.0 t, mono boom 9.20 m, stick 3.80 m and bucket 1.65 m³ (2,100 kg).

Undercarriage		LC			LC-V		
		500	600	750	500	600	750
Pad width	mm	500	600	750	500	600	750
Weight	kg	53,200	53,800	55,050	57,850	58,400	59,200
Ground pressure	kg/cm ²	1.12	0.94	0.77	1.19	1.00	0.81

Buckets Machine stability per ISO 10567* (75% of tipping capacity)

	Cutting width mm	Capacity ISO 7451 m ³	Weight kg	LC-Undercarriage (with track pads 600 mm)			LC-V-Undercarriage (with track pads 600 mm)		
				Stick length (m)			Stick length (m)		
				2.90	3.80	5.00	2.90	3.80	5.00
with counterweight 11.0 t									
STD ¹⁾	1,350	1.65	2,100	▲	▲	–	▲	▲	–
	1,550	2.00	2,250	■	△	–	■	■	–
	1,750	2.35	2,450	△	–	–	■	△	–
STD ²⁾	1,200	1.25	1,300	–	–	▲	–	–	▲
	1,350	1.50	1,400	–	–	▲	–	–	▲
	1,500	1.75	1,500	–	–	▲	–	–	■
	1,650	2.00	1,600	–	–	△	–	–	■

* Indicated loads are based on ISO 10567, at maximum reach, and may be swung 360° on firm and even ground

¹⁾ Standard bucket with Liebherr teeth Z 70 (appropriate for materials up to classification 5, according to VOB, Section C, DIN 18300)

²⁾ Standard bucket from R 946 Litronic with Liebherr teeth Z 50 (appropriate for materials up to classification 5, according to VOB, Section C, DIN 18300)

Other buckets available upon request

Max. material weight ▲ = ≤ 2.0 t/m³, ■ = ≤ 1.8 t/m³, ▲ = ≤ 1.65 t/m³, ■ = ≤ 1.5 t/m³, △ = ≤ 1.2 t/m³, – = not authorised

Dimensions Front Shovel

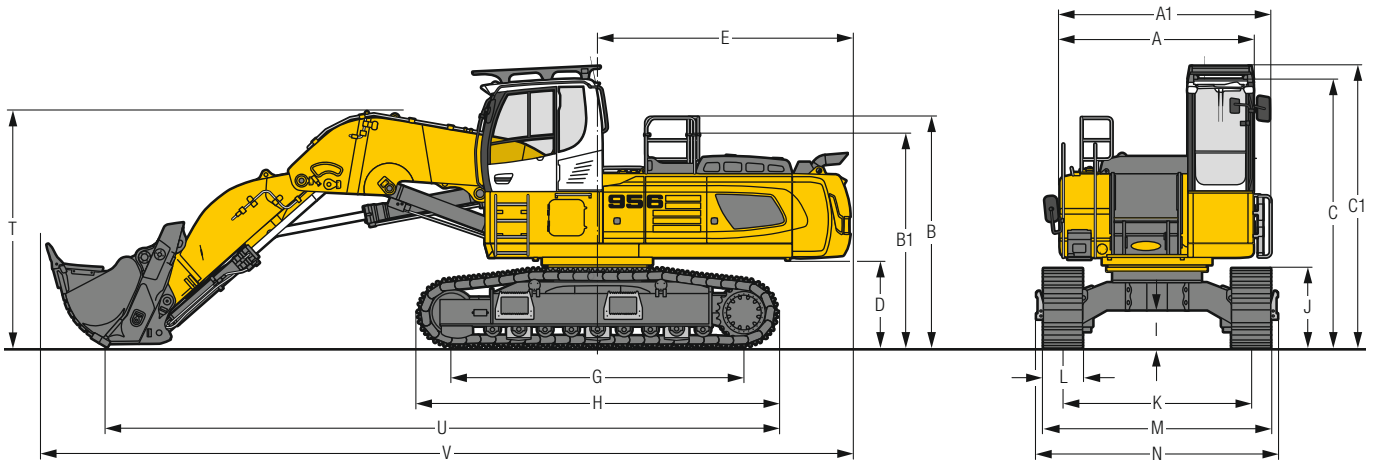

	HD	mm
A	Uppercarriage width	2,970
A1	Uppercarriage width with catwalks	3,030
B	Uppercarriage height	3,555
B1	Uppercarriage height (handrails folded)	3,305
C	Cab height	4,135
C1	Cab height with FOPS top guard	4,335
D	Counterweight ground clearance	1,355
E	Rear-end length	3,900
G	Wheelbase	4,500
H	Undercarriage length	5,550

	HD	mm
I	Undercarriage ground clearance	575
J	Track height	1,225
K	Track gauge	2,900
L	Track pad width	500 600 750
M	Width over tracks	3,465 3,500 3,650
N	Width over steps	3,725 3,725 3,725
T	Boom height	3,650
U	Length on ground	10,350
V	Overall length	12,450

Transport Dimensions

removable elements disassembled

	Shovel Equipment		
	mm		
Pad width	500	600	750
Transport width	3,725	3,725	3,725
Transport length	12,450		
Transport height	3,650		
Shovel	3.10 m ³		

Front Shovel

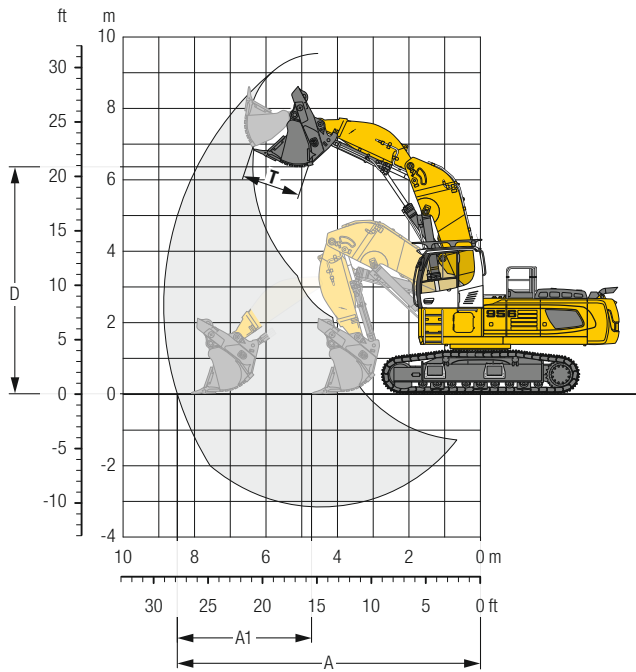

Digging Envelope

A Max. reach at ground level	m	8.50
A1 Max. crowd length	m	3.40
D Max. dumping height	m	6.30
T Bucket opening width	mm	1,640

Forces

Max. crowd force	kN	435
Max. crowd force at ground level	kN	275
Max. breakout force	kN	355

Operating Weight and Ground Pressure

The operating weight includes the basic machine with cab elevation, shovel equipment and front shovel 3.10 m³ (5,650 kg), level II.

Undercarriage	HD	
Pad width	mm	500 600
Weight	kg	56,750 57,300
Ground pressure	kg/cm²	1.17 0.98

Front Shovels

Cutting width mm	Capacity ISO 7451 m ³	Weight kg	Wear kit level	HD-Undercarriage	Shovel Equipment
1,850	2.50	4,700	II		▲
1,850	2.50	5,050	III		▲
2,150	3.10	5,150	I		■
2,150	3.10	5,650	II		■
2,150	3.10	6,050	III		■

Level I: For non-abrasive materials, such as limestone without flint inclusion, shot material or easily breakable rock, i.e., deteriorated rock, soft limestone, shale, etc.

Level II: For pre-blasted heavy rock, or deteriorated, cracked material (classification 3 to 4, accord. to DIN 18300)

Level III: For highly-abrasive materials such as rock with a high silica content, sandstone etc.

Max. material weight ▲ = ≤ 2.0 t/m³, ■ = ≤ 1.8 t/m³

Lift Capacities

with Mono Boom 6.70 m, Counterweight 9.0 t and Track Pads 600 mm

Stick 2.35 m

Under-carriage	m	3.0 m		4.5 m		6.0 m		7.5 m		9.0 m		10.5 m		m
		LC	LC-V	LC	LC-V	LC	LC-V	LC	LC-V	LC	LC-V	LC	LC-V	
9.0														10.3*
7.5														10.3*
6.0														9.3*
4.5				21.2*	21.2*	13.0*	13.0*	10.3*	10.3*					8.9*
3.0				14.5*	14.5*	14.9	15.0*	10.7	12.5*					8.1*
1.5				13.8	17.1*	10.2	13.6*	7.8	11.8*					7.5*
0				13.1	18.5*	9.8	14.4*	7.6	11.8*					7.3*
-1.5	13.7*	13.7*	14.5*	14.5*	12.8	18.9*	9.5	14.8*						7.5*
-3.0	26.2*	26.2*	19.9	23.7*	12.8	18.3*	9.5	14.4*						9.7*
-4.5			20.3	21.2*	13.1	16.6*	9.8	12.5*						12.5*
-6.0			16.6*	16.6*	12.3*	12.3*								11.9*

Stick 2.90 m

Under-carriage	m	3.0 m		4.5 m		6.0 m		7.5 m		9.0 m		10.5 m		m
		LC	LC-V	LC	LC-V	LC	LC-V	LC	LC-V	LC	LC-V	LC	LC-V	
9.0														7.8*
7.5														7.8*
6.0														7.1*
4.5				18.8*	18.8*	14.0*	14.0*	10.4*	10.4*					7.1*
3.0				15.2*	15.2*	14.1	16.3*	10.8	10.8*	7.0*	7.0*			6.9*
1.5				11.6*	11.6*	13.3	18.0*	10.3	13.0*	7.8	11.2*			6.9*
0				17.6*	17.6*	12.8	18.8*	9.5	14.6*	7.4	11.6			6.9*
-1.5	14.6*	14.6*	15.5*	15.5*	14.1	18.8*	9.5	14.5*						7.4*
-3.0	25.0*	25.0*	20.0	22.6*	12.9	17.3*	9.5	13.4*						8.6*
-4.5	24.6*	24.6*	18.8*	18.8*	13.3	14.3*								11.1*
-6.0														11.1*

Stick 3.80 m

Under-carriage	m	3.0 m		4.5 m		6.0 m		7.5 m		9.0 m		10.5 m		m
		LC	LC-V	LC	LC-V	LC	LC-V	LC	LC-V	LC	LC-V	LC	LC-V	
9.0														5.4*
7.5														5.4*
6.0														5.0*
4.5														4.8*
3.0				20.8*	20.8*	12.3*	12.3*	10.6*	10.6*	8.3	9.7*			4.8*
1.5				19.6*	19.6*	13.6	16.9*	9.9	13.2*	7.6	11.2*	6.1*	6.1*	5.2*
0	7.3*	7.3*	19.6*	19.6*	13.0	18.3*	9.5	14.2*	7.4	11.5				5.7*
-1.5	13.5*	13.5*	19.5	24.6*	12.7	18.7*	9.3	14.5*	7.2	11.4				6.4*
-3.0	20.2*	20.2*	19.6	24.3*	12.6	18.1*	9.2	14.1*	7.3	10.8*				7.1*
-4.5	29.0*	29.0*	20.1	21.6*	12.9	16.3*	9.5	12.4*						8.7*
-6.0	22.5*	22.5*	16.5*	16.5*	12.0*	12.0*								10.6*

Height
 Can be slewed through 360°
 In longitudinal position of undercarriage
 Max. reach
 * Limited by hydr. capacity

The load values are quoted in tons (t) at stick end (without bucket), and may be swung 360° on firm and even ground. Adjacent values are valid for the undercarriage when in the longitudinal position. Capacities are valid for 600 mm wide track pads. Indicated loads are based on ISO 10567 standard and do not exceed 75% of tipping or 87% of hydraulic capacity (indicated via *). Without bucket cylinder, link and lever the lift capacities will increase by 825 kg. Lifting capacity of the excavator is limited by machine stability and hydraulic capacity.

According to European Standard, EN 474-5: In the European Union excavators have to be equipped with an overload warning device, a load diagram and automatic safety check valves on hoist cylinders and stick cylinder(s), when they are used for lifting operations which require the use of lifting accessories.

Lift Capacities

with Mono Boom 6.70 m, Counterweight 11.0 t and Track Pads 600 mm

Stick 2.35 m

Under-carriage	m	3.0 m		4.5 m		6.0 m		7.5 m		9.0 m		10.5 m		m	
		LC	LC-V	LC	LC-V	LC	LC-V	LC	LC-V	LC	LC-V	LC	LC-V		
9.0													10.3*	10.3*	6.2
7.5													9.3*	9.3*	7.6
6.0													8.9*	8.9*	8.4
4.5				21.2*	21.2*	13.0*	13.0*	11.7*	11.7*				8.9*	8.9*	9.0
3.0						15.5	17.1*	11.4	13.6*	8.8	11.8*		8.5	9.1*	9.2
1.5						14.8	18.5*	11.0	14.4*	8.6	12.1*		8.3	9.7*	9.2
0						14.5	18.9*	10.8	14.8*				8.6	10.8*	9.0
-1.5	13.7*	13.7*	14.5*	14.5*	14.5	18.9*	10.8	14.8*					9.3	12.4*	8.4
-3.0	26.2*	26.2*	21.2*	21.2*	14.7	16.6*	11.0	12.5*					11.0	12.5*	7.5
-4.5			16.6*	16.6*	12.3*	12.3*							11.9*	11.9*	6.1
-6.0															
9.0													10.2*	10.2*	6.2
7.5													9.2*	9.2*	7.6
6.0													8.9*	8.9*	8.4
4.5				21.7*	21.7*	15.2*	15.2*	12.6*	12.6*	9.3*	9.3*		9.2*	9.2*	9.2
3.0						16.8	17.3*	12.4	13.6*	9.6	11.8*		9.1	9.8*	9.2
1.5						16.1	18.6*	12.0	14.5*	9.4	12.1*		9.1	9.8*	9.2
0						15.8*	18.9*	11.7	14.8*				9.4	10.9*	9.0
-1.5	15.4*	15.4*	23.5*	23.5*	15.8	18.2*	11.7	14.3*					10.3	12.4*	8.4
-3.0	26.0*	26.0*	20.9*	20.9*	16.1	16.4*							12.2	12.4*	7.5
-4.5			16.1*	16.1*									11.8*	11.8*	6.1
-6.0															
9.0													10.3*	10.3*	6.2
7.5													9.3*	9.3*	7.6
6.0													8.9*	8.9*	8.4
4.5				21.2*	21.2*	13.0*	13.0*	11.7*	11.7*				8.9*	8.9*	9.0
3.0						16.2	17.2*	11.9	13.6*	9.2	11.8*		8.8	9.1*	9.2
1.5						15.5	18.6*	11.5	14.4*	9.0	12.1*		8.7	9.7*	9.2
0						14.8*	18.9*	11.2	14.8*				8.9	10.8*	9.0
-1.5	14.1*	14.1*	23.5	23.7*	15.2	18.3*	11.2	14.4*					9.7	12.4*	8.4
-3.0	26.2*	26.2*	21.1*	21.1*	15.4	16.6*	11.5	12.5*					11.5	12.5*	7.5
-4.5			16.5*	16.5*	12.2*	12.2*							11.9*	11.9*	6.1
-6.0															

Stick 2.90 m

Under-carriage	m	3.0 m		4.5 m		6.0 m		7.5 m		9.0 m		10.5 m		m	
		LC	LC-V	LC	LC-V	LC	LC-V	LC	LC-V	LC	LC-V	LC	LC-V		
9.0													10.4*	10.4*	6.9
7.5													10.8*	10.8*	8.2
6.0													11.8*	11.8*	9.0
4.5				18.8*	18.8*	14.0*	14.0*	11.8*	11.8*	9.1	10.7*		11.5	13.0*	9.5
3.0						15.2*	15.2*	15.8	16.3*	11.5	13.0*	8.8	11.2*	11.2*	9.8
1.5						11.6*	11.6*	14.9	18.0*	11.0	14.0*	8.6	11.8*	11.8*	9.8
0						17.6*	17.6*	14.5	18.8*	10.7	14.6*	8.4	12.0*		9.5
-1.5	14.6*	14.6*	22.2	24.7*	14.4	18.6*	10.6	14.5*					10.6	14.5*	9.0
-3.0	25.0*	25.0*	22.5	22.6*	14.5	17.3*	10.7	13.4*					10.7	13.4*	8.2
-4.5	24.6*	24.6*	18.8*	18.8*	14.3*	14.3*									6.9
-6.0															
9.0													10.4*	10.4*	6.9
7.5													10.9*	10.9*	8.2
6.0													11.8*	11.8*	9.0
4.5				19.3*	19.3*	14.2*	14.2*	11.9*	11.9*	9.9	10.7*		12.5	13.1*	9.5
3.0						14.1*	14.1*	16.4*	16.4*	12.0	14.1*	9.6	11.3*	11.3*	9.8
1.5						11.9*	11.9*	16.2	18.1*	12.0	14.1*	9.3	11.8*	11.8*	9.8
0						18.2*	18.2*	15.8	18.8*	11.7	14.6*	9.2	12.0*		9.5
-1.5	15.5*	15.5*	24.2	24.6*	15.7	18.5*	11.6	14.5*					11.6	14.5*	9.0
-3.0	26.0*	26.0*	22.4*	22.4*	15.9	17.1*	11.7	13.3*					11.7	13.3*	8.2
-4.5	24.0*	24.0*	18.4*	18.4*	13.9*	13.9*									6.9
-6.0															
9.0													10.4*	10.4*	6.9
7.5													10.8*	10.8*	8.2
6.0													11.8*	11.8*	9.0
4.5				18.9*	18.9*	14.0*	14.0*	11.8*	11.8*	9.5	10.7*		12.0*	12.0*	9.5
3.0						15.0*	15.0*	16.3*	16.3*	12.0	13.0*	9.2	11.2*	11.2*	9.8
1.5						11.7*	11.7*	15.6	18.0*	11.5	14.0*	9.0	11.8*	11.8*	9.8
0						17.7*	17.7*	15.2	18.8*	11.2	14.6*	8.8	12.0*		9.5
-1.5	14.8*	14.8*	23.2	24.7*	15.0	18.6*	11.1	14.5*					11.1	14.5*	9.0
-3.0	25.2*	25.2*	22.5*	22.5*	15.2	17.3*	11.2	13.4*					11.2	13.4*	8.2
-4.5	24.5*	24.5*	18.7*	18.7*	14.3*	14.3*									6.9
-6.0															

Stick 3.80 m

Under-carriage	m	3.0 m		4.5 m		6.0 m		7.5 m		9.0 m		10.5 m		m	
		LC	LC-V	LC	LC-V	LC	LC-V	LC	LC-V	LC	LC-V	LC	LC-V		
9.0													5.4*	5.4*	8.1
7.5										6.4*	6.4*		5.0*	5.0*	9.2
6.0										9.2*	9.2*		4.8*	4.8*	9.9
4.5						12.3*	12.3*	10.6*	10.6*	9.3	9.7*		4.8*	4.8*	10.4
3.0				20.8*	20.8*	14.8*	14.8*	11.8	12.0*	9.0	10.4*	6.1*	4.9*	4.9*	10.6
1.5				19.6*	19.6*	15.3	16.9*	11.2	13.2*	8.6	11.2*	6.5*	5.2*	5.2*	10.6
0		7.3*	7.3*	19.6*	19.6*	14.7	18.3*	10.8	14.2*	8.4	11.7*		5.7*	5.7*	10.4
-1.5	13.5*	13.5*	22.0	24.6*	14.3	18.7*	10.5	14.5*	8.2	11.8*			6.4*	6.4*	9.9
-3.0	20.2*	20.2*	22.2	24.3*	14.3	18.1*	10.5	14.1*	8.3	10.8*			7.7*	7.7*	9.2
-4.5	29.0*	29.0*	21.6*	21.6*	14.6	16.3*	10.7	12.4*					9.8	10.2*	8.1
-6.0	22.5*	22.5*	16.5*	16.5*	12.0*	12.0*							10.6*	10.6*	6.4
9.0										6.9*	6.9*		5.3*	5.3*	8.1
7.5										9.2*	9.2*		4.8*	4.8*	9.2
6.0										9.8*	9.8*		4.8*	4.8*	9.9
4.5						12.5*	12.5*	10.7*	10.7*	9.8*	9.8*		4.8*	4.8*	10.4
3.0				21.2*	21.2*	15.0*	15.0*	12.1*	12.1*	9.7	10.5*	6.2*	5.0*	5.0*	10.6
1.5				19.2*	19.2*	16.6	17.1*	12.1	13.3*	9.4	11.2*	6.4*	5.2*	5.2*	10.6
0		7.9*	7.9*	19.8*	19.8*	15.9	18.4*	11.7	14.2*	9.1	11.7*		5.7*	5.7*	10.4
-1.5	14.0*	14.0*	24.0	25.1*	15.7	18.7*	11.5	14.5*	9.0	11.8*			6.5*	6.5*	9.9
-3.0	20.9*	20.9*	24.2*	24.2*	15.6	18.0*	11.5	14.0*	9.1	9.5*			7.8*	7.8*	9.2
-4.5	29.9*	29.9*	21.3*	21.3*	15.9	16.1*	11.7	12.2*					10.5*	10.5*	8.1
-6.0	21.6*	21.6*	15.9*	15.9*	11.3*	11.3*							10.6*	10.6*	6.4
9.0										6.5*	6.5*		5.4*	5.4*	8.1
7.5										9.2*	9.2*		5.0*	5.0*	9.2
6.0										9.5*	9.5*		4.8*	4.8*	9.9
4.5						12.3*	12.3*	10.6*	10.6*	9.7	9.7*		4.8*	4.8*	10.4
3.0				20.9*	20.9*	14.8*	14.8*	12.0*	12.0*	9.3	10.4*	6.1*	4.9*	4.9*	10.6
1.5				19.5*	19.5*	16.0	17.0*	11.7	13.3*	9.0	11.2*	6.5*	5.2*	5.2*	10.6
0		7.4*	7.4*	19.6*	19.6*	15.3	18.3*	11.3	14.2*	8.8	11.7*		5.7*	5.7*	10.4
-1.5	13.5*	13.5*	23.1	24.7*	15.0	18.7*	11.0	14.5*	8.6	11.8*			6.4*	6.4*	9.9
-3.0	20.3*	20.3*	23.2	24.3*	15.0	18.1*	11.0	14.1*	8.7	10.6*			7.7*	7.7*	9.2
-4.5	29.2*	29.2*	21.5*	21.5*	15.2	16.3*	11.2	12.4*					10.3*	10.3*	8.1
-6.0	22.3*	22.3*	16.4*	16.4*	11.9*	11.9*							10.6*	10.6*	6.4

Height
 Can be slewed through 360°
 In longitudinal position of undercarriage
 Max. reach
 * Limited by hydr. capacity

The load values are quoted in tons (t) at stick end (without bucket), and may be swung 360° on firm and even ground. Adjacent values are valid for the undercarriage when in the longitudinal position. Capacities are valid for 600 mm wide track pads. Indicated loads are based on ISO 10567 standard and do not exceed 75% of tipping or 87% of hydraulic capacity (indicated via *). Without bucket cylinder, link and lever the lift capacities will increase by 825 kg. Lifting capacity of the excavator is limited by machine stability and hydraulic capacity.

According to European Standard, EN 474-5: In the European Union excavators have to be equipped with an overload warning device, a load diagram and automatic safety check valves on hoist cylinders and stick cylinder(s), when they are used for lifting operations which require the use of lifting accessories.

Lift Capacities

with Mono Boom 7.60 m, Counterweight 9.0 t and Track Pads 600 mm

Stick 2.35 m

Under-carriage	m	3.0 m		4.5 m		6.0 m		7.5 m		9.0 m		10.5 m		m
LC	10.5													
LC	9.0													
LC	7.5													
LC	6.0													
LC	4.5													
LC	3.0													
LC	1.5													
LC	0													
LC	-1.5													
LC	-3.0													
LC	-4.5													
LC	-6.0													
LC-V	10.5													
LC-V	9.0													
LC-V	7.5													
LC-V	6.0													
LC-V	4.5													
LC-V	3.0													
LC-V	1.5													
LC-V	0													
LC-V	-1.5													
LC-V	-3.0													
LC-V	-4.5													
LC-V	-6.0													
HD	10.5													
HD	9.0													
HD	7.5													
HD	6.0													
HD	4.5													
HD	3.0													
HD	1.5													
HD	0													
HD	-1.5													
HD	-3.0													
HD	-4.5													
HD	-6.0													

Stick 2.90 m

Under-carriage	m	3.0 m		4.5 m		6.0 m		7.5 m		9.0 m		10.5 m		m
LC	10.5													
LC	9.0													
LC	7.5													
LC	6.0													
LC	4.5													
LC	3.0													
LC	1.5													
LC	0													
LC	-1.5													
LC	-3.0													
LC	-4.5													
LC	-6.0													
LC-V	10.5													
LC-V	9.0													
LC-V	7.5													
LC-V	6.0													
LC-V	4.5													
LC-V	3.0													
LC-V	1.5													
LC-V	0													
LC-V	-1.5													
LC-V	-3.0													
LC-V	-4.5													
LC-V	-6.0													
HD	10.5													
HD	9.0													
HD	7.5													
HD	6.0													
HD	4.5													
HD	3.0													
HD	1.5													
HD	0													
HD	-1.5													
HD	-3.0													
HD	-4.5													
HD	-6.0													

Stick 3.80 m

Under-carriage	m	3.0 m		4.5 m		6.0 m		7.5 m		9.0 m		10.5 m		m
LC	10.5													
LC	9.0													
LC	7.5													
LC	6.0													
LC	4.5													
LC	3.0													
LC	1.5													
LC	0													
LC	-1.5													
LC	-3.0													
LC	-4.5													
LC	-6.0													
LC-V	10.5													
LC-V	9.0													
LC-V	7.5													
LC-V	6.0													
LC-V	4.5													
LC-V	3.0													
LC-V	1.5													
LC-V	0													
LC-V	-1.5													
LC-V	-3.0													
LC-V	-4.5													
LC-V	-6.0													
HD	10.5													
HD	9.0													
HD	7.5													
HD	6.0													
HD	4.5													
HD	3.0													
HD	1.5													
HD	0													
HD	-1.5													
HD	-3.0													
HD	-4.5													
HD	-6.0													

Height Can be slewed through 360° In longitudinal position of undercarriage Max. reach * Limited by hydr. capacity

The load values are quoted in tons (t) at stick end (without bucket), and may be swung 360° on firm and even ground. Adjacent values are valid for the undercarriage when in the longitudinal position. Capacities are valid for 600 mm wide track pads. Indicated loads are based on ISO 10567 standard and do not exceed 75% of tipping or 87% of hydraulic capacity (indicated via *). Without bucket cylinder, link and lever the lift capacities will increase by 825 kg. Lifting capacity of the excavator is limited by machine stability and hydraulic capacity.

According to European Standard, EN 474-5: In the European Union excavators have to be equipped with an overload warning device, a load diagram and automatic safety check valves on hoist cylinders and stick cylinder(s), when they are used for lifting operations which require the use of lifting accessories.

Lift Capacities

with Mono Boom Straight 8.00 m, Counterweight 9.0 t and Track Pads 600 mm

Stick 2.35 m

Under-carriage	m	4.5 m		6.0 m		7.5 m		9.0 m		10.5 m		12.0 m		m
		HD	HD	HD	HD	HD	HD	HD	HD	HD	HD	HD	HD	
12.0														
10.5				15.0*	15.0*									11.9*
9.0				14.7*	14.7*	11.6	12.8*							9.7
7.5	20.0*	20.0*	15.4*	15.4*	11.3	12.9*	8.3	11.3*						7.8
6.0			14.9	16.7*	10.8	13.4*	8.1	11.4*						6.8
4.5					10.1	13.9*	7.8	11.5*						6.2
3.0					9.5	14.1*	7.5	11.6*	6.0	9.6				5.9
1.5					9.1	13.8*	7.2	11.3*	5.9	9.2*				5.8
0					9.0	12.9*	7.1	10.6*						6.0
-1.5			12.5*	12.5*	9.1	11.3*	7.2	9.3*						6.4
-3.0			9.9*	9.9*	9.0*	9.0*	6.7*	6.7*						5.9*
-4.5														5.9*

Stick 2.90 m

Under-carriage	m	4.5 m		6.0 m		7.5 m		9.0 m		10.5 m		12.0 m		m
		HD	HD	HD	HD	HD	HD	HD	HD	HD	HD	HD	HD	
12.0														
10.5														11.7*
9.0				14.0*	14.0*									8.9*
7.5	15.3*	15.3*	14.7*	14.7*	11.8	12.1*								7.8*
6.0			15.3	16.0*	10.9	12.9*	8.2	11.0*	6.3	8.6*				6.1
4.5			13.9	17.4*	10.2	13.6*	7.8	11.3*	6.1	9.7*				5.6
3.0					9.6	14.0*	7.5	11.4*	6.0	9.5				5.4
1.5					9.2	13.9*	7.2	11.3*	5.8	9.4*				5.3
0					12.2	15.4*	8.9	13.2*	7.0	10.8*	5.7	8.7*		5.4
-1.5			12.3	13.8*	8.9	11.9*	7.0	9.7*	5.8	7.2*				5.8
-3.0			11.2*	11.2*	9.1	9.8*	7.1	7.8*						5.9*
-4.5			7.8*	7.8*	6.7*	6.7*								5.1*

Stick 3.80 m

Under-carriage	m	4.5 m		6.0 m		7.5 m		9.0 m		10.5 m		12.0 m		m
		HD	HD	HD	HD	HD	HD	HD	HD	HD	HD	HD	HD	
12.0				10.9*	10.9*									7.3*
10.5						10.3*	10.3*							6.0*
9.0						10.6*	10.6*	8.8	9.8*					5.4*
7.5				10.6*	10.6*	11.2*	11.2*	8.7	10.2*	6.5	8.2*			5.1*
6.0	18.0*	18.0*	14.7*	14.7*	11.3	12.2*	8.4	10.5*	6.4	9.3*				4.9*
4.5			14.6	16.4*	10.5	13.0*	8.0	10.9*	6.2	9.4*				4.8*
3.0			13.4	17.7*	9.8	13.6*	7.6	11.2*	6.0	9.5*	4.8	6.3*		4.7
1.5			12.5	17.9*	9.3	13.9*	7.2	11.3*	5.8	9.4	4.7	6.4*		4.7
0			12.2	17.0*	9.0	13.6*	7.0	11.0*	5.6	9.1*				4.8
-1.5	9.9*	9.9*	12.1	15.5*	8.8	12.7*	6.9	10.3*	5.6	8.3*				5.0
-3.0	14.8*	14.8*	12.3	13.2*	8.9	11.1*	6.9	9.0*	5.7	6.7*				5.5
-4.5	10.9*	10.9*	10.2*	10.2*	8.6*	8.6*	6.6*	6.6*						4.5*

 Height
  Can be slewed through 360°
  In longitudinal position of undercarriage
  Max. reach
 * Limited by hydr. capacity

The load values are quoted in tons (t) at stick end (without bucket), and may be swung 360° on firm and even ground. Adjacent values are valid for the undercarriage when in the longitudinal position. Capacities are valid for 600 mm wide track pads. Indicated loads are based on ISO 10567 standard and do not exceed 75 % of tipping or 87 % of hydraulic capacity (indicated via *). Without bucket cylinder, link and lever the lift capacities will increase by 825 kg. Lifting capacity of the excavator is limited by machine stability and hydraulic capacity.

According to European Standard, EN 474-5: In the European Union excavators have to be equipped with an overload warning device, a load diagram and automatic safety check valves on hoist cylinders and stick cylinder(s), when they are used for lifting operations which require the use of lifting accessories.

Lift Capacities

with Mono Boom Straight 8.00 m, Counterweight 11.0 t and Track Pads 600 mm

Stick 2.35 m

Under-carriage	m	4.5 m		6.0 m		7.5 m		9.0 m		10.5 m		12.0 m		m	
HD	12.0														
	10.5			15.0*	15.0*								11.9*	11.9*	6.6
	9.0			14.7*	14.7*	12.8*	12.8*						10.2*	10.2*	8.2
	7.5	20.0*	20.0*	15.4*	15.4*	12.6	12.9*	9.3	11.3*				8.8	9.4*	9.3
	6.0			16.6	16.7*	12.0	13.4*	9.1	11.4*				7.6	9.0*	10.0
	4.5					11.3	13.9*	8.8	11.5*				7.0	8.8*	10.5
	3.0					10.8	14.1*	8.5	11.6*	6.8	9.6*		6.7	8.9*	10.7
	1.5					10.4	13.8*	8.2	11.3*	6.7	9.2*		6.6	8.8*	10.7
	0					10.3	12.9*	8.1	10.6*				6.8	8.2*	10.4
	-1.5			12.5*	12.5*	10.3	11.3*	8.2	9.3*				7.3	7.3*	10.0
-3.0			9.9*	9.9*	9.0*	9.0*	6.7*	6.7*				5.9*	5.9*	9.2	
-4.5															

Stick 2.90 m

Under-carriage	m	4.5 m		6.0 m		7.5 m		9.0 m		10.5 m		12.0 m		m		
HD	12.0															
	10.5			14.0*	14.0*									11.7*	11.7*	5.2
	9.0			14.0*	14.0*	12.1*	12.1*							7.8*	7.8*	7.5
	7.5	15.3*	15.3*	14.7*	14.7*	12.4*	12.4*	9.4	10.9*					7.2*	7.2*	8.9
	6.0			16.0*	16.0*	12.2	12.9*	9.2	11.0*	7.1	8.6*			6.9*	6.9*	10.6
	4.5			15.6	17.4*	11.5	13.6*	8.8	11.3*	7.0	9.7*			6.4	6.8*	11.0
	3.0					10.9	14.0*	8.5	11.4*	6.8	9.6*			6.2	6.9*	11.2
	1.5					10.4	13.9*	8.2	11.3*	6.6	9.4*			6.1	7.1*	11.2
	0					13.9	15.4*	10.2	13.2*	8.0	10.8*	6.6	8.7*	6.2	7.5*	11.0
	-1.5			13.8*	13.8*	10.2	11.9*	8.0	9.7*	6.7	7.2*			6.6	7.0*	10.6
-3.0			11.2*	11.2*	9.8*	9.8*	7.8*	7.8*					5.9*	5.9*	9.9	
-4.5			7.8*	7.8*	6.7*	6.7*							5.1*	5.1*	8.5	

Stick 3.80 m

Under-carriage	m	4.5 m		6.0 m		7.5 m		9.0 m		10.5 m		12.0 m		m		
HD	12.0			10.9*	10.9*								7.3*	7.3*	6.9	
	10.5					10.3*	10.3*						6.0*	6.0*	8.8	
	9.0					10.6*	10.6*	9.8	9.8*				5.4*	5.4*	10.0	
	7.5			10.6*	10.6*	11.2*	11.2*	9.7	10.2*	7.4	8.2*		5.1*	5.1*	10.9	
	6.0	18.0*	18.0*	14.7*	14.7*	12.2*	12.2*	9.4	10.5*	7.3	9.3*		4.9*	4.9*	11.5	
	4.5			16.3	16.4*	11.8	13.0*	9.0	10.9*	7.1	9.4*		4.8*	4.8*	11.9	
	3.0			15.0	17.7*	11.1	13.6*	8.6	11.2*	6.8	9.5*	5.5	6.3*	4.8*	4.8*	12.1
	1.5			14.2	17.9*	10.5	13.9*	8.2	11.3*	6.6	9.4*	5.4	6.4*	5.0*	5.0*	12.1
	0			13.8	17.0*	10.2	13.6*	8.0	11.0*	6.5	9.1*			5.2*	5.2*	11.9
	-1.5	9.9*	9.9*	13.8	15.5*	10.1	12.7*	7.9	10.3*	6.4	8.3*			5.6*	5.6*	11.5
-3.0	14.8*	14.8*	13.2*	13.2*	10.1	11.1*	7.9	9.0*	6.5	6.7*			5.7*	5.7*	10.9	
-4.5	10.9*	10.9*	10.2*	10.2*	8.6*	8.6*	6.6*	6.6*					4.5*	4.5*	9.9	

Height Can be slewed through 360° In longitudinal position of undercarriage Max. reach * Limited by hydr. capacity

The load values are quoted in tons (t) at stick end (without bucket), and may be swung 360° on firm and even ground. Adjacent values are valid for the undercarriage when in the longitudinal position. Capacities are valid for 600 mm wide track pads. Indicated loads are based on ISO 10567 standard and do not exceed 75 % of tipping or 87 % of hydraulic capacity (indicated via *). Without bucket cylinder, link and lever the lift capacities will increase by 825 kg. Lifting capacity of the excavator is limited by machine stability and hydraulic capacity.

According to European Standard, EN 474-5: In the European Union excavators have to be equipped with an overload warning device, a load diagram and automatic safety check valves on hoist cylinders and stick cylinder(s), when they are used for lifting operations which require the use of lifting accessories.

Lift Capacities

with Two-Piece Boom 7.90 m (Main Boom 4.70 m), Counterweight 9.0 t and Track Pads 600 mm

Stick 2.35 m

Under-carriage	m	3.0 m		4.5 m		6.0 m		7.5 m		9.0 m		10.5 m		m		
		Height	Can be slewed through 360°	Height	Can be slewed through 360°	Height	Can be slewed through 360°	Height	Can be slewed through 360°	Height	Can be slewed through 360°	Height	Can be slewed through 360°			
LC	12.0												18.0°	18.0°	3.4	
	10.5												12.0°	12.0°	6.4	
	9.0												9.2	10.2°	8.1	
	7.5	29.4°	29.4°	18.6°	18.6°	15.5°	15.5°	11.0	12.8°				7.1	9.4°	9.2	
	6.0			20.5°	20.5°	15.4°	15.6°	11.1	12.8°	7.5	10.9°		6.0	9.0°	9.9	
	4.5			19.6°	19.6°	14.2°	17.0°	10.7	13.2°	7.7	10.9°		5.4	8.9°	10.4	
	3.0			20.7°	20.8°	14.1°	16.8°	10.7	13.1°	7.5	10.7°		5.1	8.4°	10.6	
	1.5			20.6	23.1°	14.0	16.8°	10.1	13.1°	7.1	10.7°	5.2	8.6	5.1	8.1°	10.6
	0			19.5	24.2°	13.0	17.1°	9.6	13.3°	6.7	10.9°			5.1	6.8°	10.4
	-1.5	31.0°	31.0°	19.1	24.7°	12.5	17.7°	9.0	13.8°	6.5	9.9°			5.6	5.6°	9.9
	-3.0	37.6°	37.6°	19.2	24.5°	12.5	17.7°	8.6	12.2°	5.2°	5.2°			3.9°	3.9°	9.1
	-4.5	33.3°	33.3°	19.7	21.1°	12.3	13.1°	5.6°	5.6°					5.2°	5.2°	7.6
	-6.0															
LC-V	12.0												16.9°	16.9°	3.4	
	10.5			18.5°	18.5°	15.4°	15.4°						11.8°	11.8°	6.4	
	9.0			17.8°	17.8°	15.2°	15.2°	12.0	12.8°				9.8	10.1°	8.1	
	7.5			20.7°	20.7°	15.7°	15.7°	11.8	12.8°	8.3	10.9°		7.8	9.4°	9.2	
	6.0			20.1°	20.1°	15.5	16.5°	11.5	13.1°	8.6	10.9°		6.6	9.0°	9.9	
	4.5			19.6°	19.6°	15.0	17.0°	11.3	13.3°	8.5	10.9°		6.0	8.9°	10.4	
	3.0			21.0°	21.0°	14.8	16.8°	11.3	13.1°	8.3	10.7°		5.8	8.7°	10.6	
	1.5			22.2	23.3°	15.0	16.8°	11.1	13.1°	7.9	10.8°	5.7	8.0°	5.6	7.6°	10.6
	0	17.4°	17.4°	21.5	24.2°	14.3	17.1°	10.5	13.3°	7.5	10.9°			5.8	6.7°	10.4
	-1.5	32.1°	32.1°	21.1	24.7°	13.8	17.7°	9.9	13.8°	7.2	9.7°			5.5°	5.5°	9.9
	-3.0	37.4°	37.4°	21.2	24.4°	13.8	17.6°	9.6	11.9°	4.4°	4.4°			3.8°	3.8°	9.1
	-4.5	32.6°	32.6°	20.3°	20.3°	12.4°	12.4°							5.4°	5.4°	7.6
	-6.0															
HD	12.0												17.8°	17.8°	3.4	
	10.5			18.6°	18.6°	15.5°	15.5°						11.9°	11.9°	6.4	
	9.0			17.7°	17.7°	15.2°	15.2°	11.5	12.8°				9.6	10.2°	8.1	
	7.5	29.2°	29.2°	20.5°	20.5°	15.6°	15.6°	11.5	12.8°	7.9	10.9°		7.5	9.4°	9.2	
	6.0			20.2°	20.2°	15.1°	16.4°	11.2	13.0°	8.2	10.9°		6.3	9.0°	9.9	
	4.5			19.6°	19.6°	14.6	17.0°	11.0	13.2°	8.1	10.9°		5.7	8.9°	10.4	
	3.0			20.9°	20.9°	14.4	16.8°	11.0	13.1°	7.9	10.7°		5.4	8.4°	10.6	
	1.5			21.6	23.1°	14.6	16.8°	10.6	13.1°	7.5	10.8°	5.5	8.7°	5.3	7.7°	10.6
	0			20.5	24.2°	13.7	17.1°	10.0	13.3°	7.1	10.9°			5.4	6.8°	10.4
	-1.5	31.2°	31.2°	20.1	24.7°	13.2	17.7°	9.5	13.8°	6.8	9.9°			5.6°	5.6°	9.9
	-3.0	37.6°	37.6°	20.2	24.5°	13.1	17.7°	9.1	12.1°	5.1°	5.1°			3.8°	3.8°	9.1
	-4.5	33.2°	33.2°	20.7	20.9°	12.9	12.9°	5.4°	5.4°					5.2°	5.2°	7.6
	-6.0															

Stick 2.90 m

Under-carriage	m	3.0 m		4.5 m		6.0 m		7.5 m		9.0 m		10.5 m		m		
		Height	Can be slewed through 360°	Height	Can be slewed through 360°	Height	Can be slewed through 360°	Height	Can be slewed through 360°	Height	Can be slewed through 360°	Height	Can be slewed through 360°			
LC	12.0												14.3°	14.3°	4.9	
	10.5					14.6°	14.6°						14.4°	14.4°	7.3	
	9.0												14.4°	14.4°	8.8	
	7.5					15.8°	15.8°	15.0°	15.0°	11.2	12.4°		11.3	12.3°	9.8	
	6.0			21.6°	21.6°	14.8	15.9°	10.9	12.7°	8.2	10.7°		8.0	10.6°	10.5	
	4.5			20.2°	20.2°	14.2	16.7°	10.6	13.0°	8.1	10.7°		5.5	8.9°	10.9	
	3.0			20.6	20.7°	14.0	16.7°	10.5	13.1°	7.8	10.6°		5.4	8.8	11.1	
	1.5			20.7	22.5°	14.0	16.7°	10.3	12.9°	7.4	10.6°	5.2	8.6	4.5	7.2°	11.1
	0	18.0°	18.0°	19.9	23.8°	13.2	16.8°	9.6	13.0°	6.9	10.8°	5.0	8.2°	4.7	6.5°	10.9
	-1.5	27.3°	27.3°	19.1	24.3°	12.6	17.3°	9.2	13.6°	6.5	10.6°			5.0	5.5°	10.5
	-3.0	38.1°	38.1°	19.0	24.6°	12.4	17.8°	8.7	13.2°	6.4	8.4°			4.0°	4.0°	9.8
	-4.5	35.7°	35.7°	19.5	23.2°	12.2	15.5°	8.5	9.3°					4.2°	4.2°	8.5
	-6.0	23.1°	23.1°	13.3°	13.3°									8.1°	8.1°	5.6
LC-V	12.0					15.2°	15.2°						14.4°	14.4°	4.9	
	10.5												14.4°	14.4°	7.3	
	9.0									12.1	12.3°		11.9	12.4°	8.8	
	7.5			16.4°	16.4°	15.1°	15.1°	11.9	12.4°	8.8	10.6°		8.8	10.7°	9.8	
	6.0			21.3°	21.3°	15.7	16.0°	11.5	12.8°	8.9	10.7°		6.1	7.5°	10.5	
	4.5			20.2°	20.2°	15.0	16.8°	11.2	13.1°	8.8	10.7°		6.1	9.0°	10.9	
	3.0			20.8°	20.8°	14.7	16.7°	11.1	13.1°	8.6	10.6°	6.0	8.9°	5.5	7.0°	11.1
	1.5			21.9	22.6°	14.8	16.7°	11.2	12.9°	8.2	10.6°	5.8	8.8°	5.2	7.2°	11.1
	0	18.7°	18.7°	21.8	23.8°	14.5	16.9°	10.6	13.1°	7.7	10.8°	5.6	8.1°	5.3	6.4°	10.9
	-1.5	28.1°	28.1°	21.1	24.4°	13.9	17.3°	10.2	13.7°	7.3	10.6°			5.4°	5.4°	10.5
	-3.0	38.6°	38.6°	21.0	24.6°	13.7	17.8°	9.6	13.0°	7.1	8.1°			3.9°	3.9°	9.8
	-4.5	35.2°	35.2°	21.5	22.9°	13.5	15.0°	8.7°	8.7°					4.4°	4.4°	8.5
	-6.0	21.1°	21.1°	12.0°	12.0°									9.3°	9.3°	5.6
HD	12.0					14.7°	14.7°						14.4°	14.4°	4.9	
	10.5												14.4°	14.4°	7.3	
	9.0									11.7	12.3°		11.5	12.4°	8.8	
	7.5			15.9°	15.9°	15.1°	15.1°	11.5	12.4°	8.4	10.6°		8.4	10.6°	9.8	
	6.0			21.5°	21.5°	15.3	15.9°	11.2	12.7°	8.5	10.7°		6.7	7.2°	10.5	
	4.5			20.2°	20.2°	14.6	16.7°	10.9	13.1°	8.5	10.7°		5.8	7.0°	10.9	
	3.0			20.7°	20.7°	14.4	16.7°	10.8	13.1°	8.2	10.6°	5.7	8.9°	4.9	7.0°	11.1
	1.5			21.3	22.5°	14.4	16.7°	10.8	12.9°	7.8	10.6°	5.5	8.8°	4.8	7.2°	11.1
	0	18.1°	18.1°	20.9	23.8°	13.9	16.8°	10.1	13.0°	7.3	10.8°	5.3	8.2°	5.0	6.4°	10.9
	-1.5	27.4°	27.4°	20.2	24.3°	13.2	17.3°	9.7	13.6°	6.9	10.6°			5.3	5.4°	10.5
	-3.0	38.3°	38.3°	20.0	24.6°	13.0	17.8°	9.2	13.2°	6.7	8.4°			4.0°	4.0°	9.8
	-4.5	35.6°	35.6°	20.5	23.1°	12.8	15.4°	9.0	9.2°					4.3°	4.3°	8.5
	-6.0	22.8°	22.8°	13.1°	13.1°									8.2°	8.2°	5.6

Height
 Can be slewed through 360°
 In longitudinal position of undercarriage
 Max. reach
 * Limited by hydr. capacity

The load values are quoted in tons (t) at stick end (without bucket), and may be swung 360° on firm and even ground. Adjacent values are valid for the undercarriage when in the longitudinal position. Capacities are valid for 600 mm wide track pads with adjusting cylinder in optimal position. Indicated loads are based on ISO 10567 standard and do not exceed 75% of tipping or 87% of hydraulic capacity (indicated via *). Without bucket cylinder, link and lever the lift capacities will increase by 825 kg. Lifting capacity of the excavator is limited by machine stability and hydraulic capacity.

According to European Standard, EN 474-5: In the European Union excavators have to be equipped with an overload warning device, a load diagram and automatic safety check valves on hoist cylinders and stick cylinder(s), when they are used for lifting operations which require the use of lifting accessories.

Stick 3.80 m

Under-carriage	3.0 m		4.5 m		6.0 m		7.5 m		9.0 m		10.5 m		12.0 m		m		
	↕	↔	↕	↔	↕	↔	↕	↔	↕	↔	↕	↔	↕	↔	↕	↔	
LC	12.0				10.5*	10.5*							7.4*	7.4*	6.7	6.7	
	10.5				10.7*	10.7*							6.1*	6.1*	8.6	8.6	
	9.0				10.3*	10.3*			8.3	9.6*			5.4*	5.4*	9.9	9.9	
	7.5				11.1*	11.1*			8.6	10.1*	5.9	7.5*	5.1*	5.1*	10.8	10.8	
	6.0			16.9*	16.9*	14.6*	14.6*	11.0	12.2*	8.4	10.3*	6.0	8.9*	4.7	4.9*	11.4	11.4
	4.5			21.4	21.5*	14.4	16.1*	10.6	12.7*	8.3	10.5*	6.0	8.9*	4.3	4.8*	11.8	11.8
	3.0	19.3*	19.3*	20.6*	20.7*	14.0	16.8*	10.4	13.0*	8.2	10.6*	5.8	8.8	4.1	4.9*	12.0	12.0
	1.5	15.6*	15.6*	20.5	21.7*	13.8	16.6*	10.4	12.9*	7.9	10.4*	5.6	8.7	4.0	5.0*	12.0	12.0
	0	18.2*	18.2*	20.7	23.1*	13.7	16.6*	9.9	12.8*	7.4	10.4*	5.3	8.6	4.0	5.3*	11.8	11.8
	-1.5	23.6*	23.6*	19.5	23.8*	12.8	16.8*	9.3	13.0*	6.9	10.8*	5.0	8.3*	4.3	5.2*	11.4	11.4
-3.0	30.6*	30.6*	19.0	24.4*	12.3	17.5*	9.0	13.7*	6.5	10.3*	4.9	5.8*	4.1*	4.1*	10.8	10.8	
-4.5	38.2*	38.2*	19.0	24.3*	12.3	17.5*	8.5	12.4*	6.3	7.4*			3.2*	3.2*	9.8	9.8	
-6.0	33.3*	33.3*	19.5	20.5*	12.1	12.9*	6.6*	6.6*					4.7*	4.7*	7.9	7.9	
LC-V	12.0				10.7*	10.7*							7.2*	7.2*	6.7	6.7	
	10.5				10.7*	10.7*							6.0*	6.0*	8.6	8.6	
	9.0				10.3*	10.3*			9.1	9.7*			5.4*	5.4*	9.9	9.9	
	7.5				11.3*	11.3*			11.4*	11.4*	6.5	7.8*	5.1*	5.1*	10.8	10.8	
	6.0			19.4*	19.4*	15.2*	15.2*	11.7	12.2*	9.0	10.3*	6.7	8.9*	4.9*	4.9*	11.4	11.4
	4.5	18.0*	18.0*	21.5*	21.5*	15.2	16.2*	11.3	12.7*	8.8	10.5*	6.6	8.9*	4.8	4.8*	11.8	11.8
	3.0	19.9*	19.9*	20.7*	20.7*	14.8	16.8*	11.0	13.0*	8.7	10.6*	6.4	8.8*	4.6	4.9*	12.0	12.0
	1.5	15.6*	15.6*	21.6	21.8*	14.6	16.6*	11.0	12.9*	8.7	10.4*	6.2	8.7*	4.5	5.0*	12.0	12.0
	0	18.6*	18.6*	21.9	23.2*	14.8	16.6*	10.8	12.8*	8.1	10.4*	5.9	8.8*	4.6	5.3*	11.8	11.8
	-1.5	24.1*	24.1*	21.4	23.8*	14.1	16.9*	10.3	13.1*	7.6	10.8*	5.6	8.2*	4.9	5.1*	11.4	11.4
-3.0	31.2*	31.2*	20.9	24.5*	13.6	17.5*	9.9	13.7*	7.2	10.2*	5.3*	5.3*	4.0*	4.0*	10.8	10.8	
-4.5	38.0*	38.0*	21.0	24.2*	13.6	17.4*	9.5	12.1*	6.9*	6.9*			3.3*	3.3*	9.8	9.8	
-6.0	32.5*	32.5*	19.7*	19.7*	12.2*	12.2*	5.7*	5.7*					4.9*	4.9*	7.9	7.9	
HD	12.0				10.5*	10.5*							7.3*	7.3*	6.7	6.7	
	10.5				10.7*	10.7*							6.0*	6.0*	8.6	8.6	
	9.0				10.3*	10.3*			8.7	9.6*			5.4*	5.4*	9.9	9.9	
	7.5				11.2*	11.2*			8.8	10.1*	6.2	7.6*	5.1*	5.1*	10.8	10.8	
	6.0			17.2*	17.2*	14.7*	14.7*	11.3	12.2*	8.7	10.3*	6.3	8.9*	4.9*	4.9*	11.4	11.4
	4.5	18.5*	18.5*	21.5*	21.5*	14.9	16.2*	11.0	12.7*	8.6	10.5*	6.3	8.9*	4.6	4.8*	11.8	11.8
	3.0	19.4*	19.4*	20.7*	20.7*	14.4	16.8*	10.7	13.0*	8.5	10.6*	6.1	8.8*	4.3	4.9*	12.0	12.0
	1.5	15.6*	15.6*	21.1*	21.7*	14.2	16.6*	10.7	12.9*	8.3	10.4*	5.9	8.7*	4.2	5.0*	12.0	12.0
	0	18.3*	18.3*	21.3	23.2*	14.4	16.6*	10.4	12.8*	7.8	10.4*	5.6	8.8*	4.3	5.3*	11.8	11.8
	-1.5	23.7*	23.7*	20.5	23.8*	13.5	16.9*	9.8	13.0*	7.3	10.8*	5.3	8.3*	4.6	5.2*	11.4	11.4
-3.0	30.7*	30.7*	20.0	24.5*	13.0	17.5*	9.5	13.7*	6.8	10.3*	5.2	5.7*	4.1*	4.1*	10.8	10.8	
-4.5	38.2*	38.2*	20.0	24.3*	13.0	17.5*	9.0	12.3*	6.7	7.3*			3.3*	3.3*	9.8	9.8	
-6.0	33.2*	33.2*	20.3*	20.3*	12.8*	12.8*	6.4*	6.4*					4.8*	4.8*	7.9	7.9	

 Height
  Can be slewed through 360°
  In longitudinal position of undercarriage
  Max. reach
 * Limited by hydr. capacity

The load values are quoted in tons (t) at stick end (without bucket), and may be swung 360° on firm and even ground. Adjacent values are valid for the undercarriage when in the longitudinal position. Capacities are valid for 600 mm wide track pads with adjusting cylinder in optimal position. Indicated loads are based on ISO 10567 standard and do not exceed 75% of tipping or 87% of hydraulic capacity (indicated via *). Without bucket cylinder, link and lever the lift capacities will increase by 825 kg. Lifting capacity of the excavator is limited by machine stability and hydraulic capacity.

According to European Standard, EN 474-5: In the European Union excavators have to be equipped with an overload warning device, a load diagram and automatic safety check valves on hoist cylinders and stick cylinder(s), when they are used for lifting operations which require the use of lifting accessories.

Lift Capacities

with Two-Piece Boom 7.90 m (Main Boom 4.70 m), Counterweight 11.0 t and Track Pads 600 mm

Stick 2.35 m

Under-carriage	m	3.0 m		4.5 m		6.0 m		7.5 m		9.0 m		10.5 m		m	
		↕	↔	↕	↔	↕	↔	↕	↔	↕	↔	↕	↔		
LC	12.0												18.0°	18.0°	3.4
	10.5												12.0°	12.0°	6.4
	9.0												10.2°	10.2°	8.1
	7.5	29.4°	29.4°	18.6°	18.6°	15.5°	15.5°	12.2	12.8°				8.1	9.4°	9.2
	6.0			20.3°	20.3°	15.6°	15.6°	12.0	13.0°	8.5	10.9°		6.9	9.0°	9.9
	4.5			19.6°	19.6°	15.2	17.0°	11.5	13.2°	8.7	10.9°		6.2	8.9°	10.4
	3.0			20.8°	20.8°	15.0	16.8°	11.4	13.1°	8.5	10.7°	6.0	5.9	8.4°	10.6
	1.5			22.5	23.1°	15.2	16.8°	11.4	13.1°	8.1	10.7°	5.9	5.8	7.7°	10.6
	0			22.0	24.2°	14.7	17.1°	10.8	13.3°	7.7	10.9°		6.0	6.8°	10.4
	-1.5	31.0°	31.0°	21.6	24.7°	14.2	17.7°	10.3	13.8°	7.5	9.9°		5.6	5.6°	9.9
-3.0	37.6°	37.6°	21.7	24.5°	14.2	17.7°	9.9	12.2°	5.2°	5.2°		3.9°	3.9°	9.1	
-4.5	33.3°	33.3°	21.1°	21.1°	13.1°	13.1°	5.6°	5.6°				5.2°	5.2°	7.6	
-6.0															
LC-V	12.0												16.9°	16.9°	3.4
	10.5												11.8°	11.8°	6.4
	9.0							12.8°	12.8°				10.1°	10.1°	8.1
	7.5			18.5°	18.5°	15.4°	15.4°	12.8°	12.8°	9.3	10.9°		8.7	9.4°	9.2
	6.0			20.7°	20.7°	15.7°	15.7°	12.7	12.8°	9.6	10.9°		7.5	9.0°	9.9
	4.5			20.1°	20.1°	16.5°	16.5°	12.4	13.1°	9.3	10.7°		6.9	8.9°	10.4
	3.0			19.6°	19.6°	16.0	17.0°	12.1	13.3°	9.5	10.9°		6.5	8.9°	10.4
	1.5			21.0°	21.0°	15.8	16.8°	12.0	13.1°	9.3	10.7°	6.6	6.5	8.4°	10.6
	0			23.3°	23.3°	15.9	16.8°	12.1	13.1°	8.9	10.8°	6.5	6.5	7.6°	10.6
	-1.5	17.4°	17.4°	23.9	24.2°	16.0	17.1°	11.8	13.3°	8.5	10.9°		6.7	6.7°	10.4
-3.0	32.1°	32.1°	23.6	24.7°	15.5	17.7°	11.2	13.8°	8.2	9.7°		5.5°	5.5°	9.9	
-4.5	37.4°	37.4°	23.7	24.4°	15.4	17.6°	10.8	11.9°	4.4°	4.4°		3.8°	3.8°	9.1	
-6.0	32.6°	32.6°	20.3°	20.3°	12.4°	12.4°						5.4°	5.4°	7.6	
HD	12.0												17.8°	17.8°	3.4
	10.5												11.9°	11.9°	6.4
	9.0							12.5	12.8°				10.2°	10.2°	8.1
	7.5	29.2°	29.2°	17.7°	17.7°	15.2°	15.2°	12.4	12.8°	8.9	10.9°		8.5	9.4°	9.2
	6.0			20.5°	20.5°	15.6°	15.6°	12.4	13.0°	9.2	10.9°		7.2	9.0°	9.9
	4.5			20.2°	20.2°	16.2	16.4°	12.1	13.0°	9.1	10.9°		6.6	8.9°	10.4
	3.0			19.6°	19.6°	15.6	17.0°	11.8	13.2°	9.1	10.9°		6.2	8.4°	10.6
	1.5			20.9°	20.9°	15.4	16.8°	11.7	13.1°	8.9	10.7°	6.3	6.2	8.4°	10.6
	0			23.0	23.1°	15.5	16.8°	11.9	13.1°	8.5	10.8°	6.2	6.2	8.1°	10.6
	-1.5	31.2°	31.2°	23.1	24.2°	15.4	17.1°	11.3	13.3°	8.1	10.9°		6.3	6.8°	10.4
-3.0	37.6°	37.6°	22.6	24.7°	14.9	17.7°	10.7	13.8°	7.8	9.9°		5.6°	5.6°	9.9	
-4.5	33.2°	33.2°	22.7	24.5°	14.8	17.7°	10.3	12.1°	5.1°	5.1°		3.8°	3.8°	9.1	
-6.0			20.9°	20.9°	12.9°	12.9°	5.4°	5.4°				5.2°	5.2°	7.6	

Stick 2.90 m

Under-carriage	m	3.0 m		4.5 m		6.0 m		7.5 m		9.0 m		10.5 m		m	
		↕	↔	↕	↔	↕	↔	↕	↔	↕	↔	↕	↔		
LC	12.0												18.0°	18.0°	3.4
	10.5												12.0°	12.0°	6.4
	9.0												10.2°	10.2°	8.1
	7.5												14.3°	14.3°	9.2
	6.0			14.6°	14.6°								14.4°	14.4°	10.5
	4.5			15.8°	15.8°	15.0°	15.0°	12.1	12.4°	9.0	10.6°		6.3	9.0°	10.9
	3.0			21.6°	21.6°	15.9°	15.9°	11.7	12.7°	9.1	10.7°		6.2	8.9°	11.1
	1.5			20.2°	20.2°	15.3	16.7°	11.4	13.0°	8.4	10.6°	6.3	5.5	6.5°	10.9
	0			22.1	22.5°	15.0	16.7°	11.3	12.9°	8.4	10.6°	5.8	5.5	5.5°	10.5
	-1.5	18.0°	18.0°	22.4	23.8°	14.9	16.8°	10.9	13.0°	7.9	10.8°		5.5	5.5°	10.9
-3.0	27.3°	27.3°	21.7	24.3°	14.3	17.3°	10.5	13.6°	7.5	10.6°		4.0°	4.0°	9.8	
-4.5	38.1°	38.1°	21.5	24.6°	14.0	17.8°	9.9	13.2°	7.4	8.4°		4.2°	4.2°	8.5	
-6.0	23.1°	23.1°	13.3°	13.3°	13.9	15.5°	9.3°	9.3°				8.1°	8.1°	5.6	
LC-V	12.0												16.9°	16.9°	3.4
	10.5												11.8°	11.8°	6.4
	9.0												10.1°	10.1°	8.1
	7.5												14.4°	14.4°	9.2
	6.0			15.2°	15.2°								14.4°	14.4°	10.5
	4.5			16.4°	16.4°	15.1°	15.1°	12.4	12.4°	9.8	10.6°		6.9	7.5°	10.9
	3.0			21.3°	21.3°	16.0°	16.0°	12.4	12.8°	9.6	10.7°		6.9	8.9°	11.1
	1.5			20.2°	20.2°	16.0	16.8°	12.0	13.1°	9.5	10.7°	6.6	6.5	8.9°	10.9
	0			20.8°	20.8°	15.7	16.7°	11.9	13.1°	9.5	10.6°	6.9	6.7	8.8°	10.9
	-1.5	18.7°	18.7°	22.6°	22.6°	15.7	16.7°	11.9	12.9°	9.1	10.6°	6.7	6.7	8.8°	10.9
-3.0	28.1°	28.1°	23.6	23.8°	16.0	16.9°	11.8	13.7°	8.3	10.6°		5.4	5.4°	10.5	
-4.5	38.6°	38.6°	23.5	24.6°	15.4	17.8°	10.9	13.0°	8.1°	8.1°		3.9°	3.9°	9.8	
-6.0	35.2°	35.2°	22.9°	22.9°	15.0°	15.0°	8.7°	8.7°				4.4°	4.4°	8.5	
	21.1°	21.1°	12.0°	12.0°								9.3°	9.3°	5.6	
HD	12.0												17.8°	17.8°	3.4
	10.5												11.9°	11.9°	6.4
	9.0												10.2°	10.2°	8.1
	7.5												14.4°	14.4°	9.2
	6.0												14.4°	14.4°	10.5
	4.5			14.7°	14.7°								14.4°	14.4°	10.9
	3.0			15.9°	15.9°	15.1°	15.1°	12.4	12.4°	9.4	10.6°		6.6	9.0°	11.1
	1.5			21.5°	21.5°	15.9°	15.9°	12.1	12.7°	9.3	10.7°		6.6	8.9°	10.9
	0			20.2°	20.2°	15.7	16.7°	11.7	13.1°	9.3	10.7°	6.6	6.5	8.9°	10.9
	-1.5	18.1°	18.1°	22.5°	22.5°	15.4	16.7°	11.6	12.9°	8.8	10.6°	6.5	6.5	8.9°	10.9
-3.0	27.4°	27.4°	22.7	24.3°	14.9	17.3°	10.9	13.6°	7.9	10.6°		5.4	5.4°	10.5	
-4.5	38.3°	38.3°	22.5	24.6°	14.7	17.8°	10.4	13.2°	7.7	8.4°		4.0°	4.0°	9.8	
-6.0	22.8°	22.8°	13.1°	13.1°	14.5	15.4°	9.2°	9.2°				4.3°	4.3°	8.5	

↕ Height ↔ Can be slewed through 360° In longitudinal position of undercarriage Max. reach * Limited by hydr. capacity

The load values are quoted in tons (t) at stick end (without bucket), and may be swung 360° on firm and even ground. Adjacent values are valid for the undercarriage when in the longitudinal position. Capacities are valid for 600 mm wide track pads with adjusting cylinder in optimal position. Indicated loads are based on ISO 10567 standard and do not exceed 75% of tipping or 87% of hydraulic capacity (indicated via *). Without bucket cylinder, link and lever the lift capacities will increase by 825 kg. Lifting capacity of the excavator is limited by machine stability and hydraulic capacity.

According to European Standard, EN 474-5: In the European Union excavators have to be equipped with an overload warning device, a load diagram and automatic safety check valves on hoist cylinders and stick cylinder(s), when they are used for lifting operations which require the use of lifting accessories.

Stick 3.80 m

Under-carriage	3.0 m		4.5 m		6.0 m		7.5 m		9.0 m		10.5 m		12.0 m		m			
	↕	↔	↕	↔	↕	↔	↕	↔	↕	↔	↕	↔	↕	↔	↕	↔		
LC	12.0				10.5*	10.5*									7.4*	7.4*	6.7	
	10.5				10.7*	10.7*									6.1*	6.1*	8.6	
	9.0				10.3*	10.3*									5.4*	5.4*	9.9	
	7.5				11.1*	11.1*									5.1*	5.1*	10.8	
	6.0			16.9*	16.9*	14.6*	14.6*	11.9	12.2*	9.1	10.3*	6.8	8.9*			4.9*	4.9*	11.4
	4.5			21.5*	21.5*	15.5	16.1*	11.5	12.7*	9.0	10.5*	6.8	8.9*			4.8*	4.8*	11.8
	3.0	19.3*	19.3*	20.7*	20.7*	15.0	16.8*	11.2	13.0*	8.9	10.6*	6.6	8.8*	4.8	4.9*	4.8	4.9*	12.0
	1.5	15.6*	15.6*	21.7*	21.7*	14.8*	16.6*	11.1	12.9*	8.9	10.4*	6.4	8.7*			4.7	5.0*	12.0
	0	18.2*	18.2*	22.1	23.1*	15.0	16.6*	11.2	12.8*	8.4	10.4*	6.1	8.8*			4.8	5.3*	11.8
	-1.5	23.6*	23.6*	22.0	23.8*	14.5	16.8*	10.6	13.0*	7.9	10.8*	5.8	8.3*			5.1	5.2*	11.4
-3.0	30.6*	30.6*	21.5	24.4*	14.0	17.5*	10.2	13.7*	7.5	10.3*	5.8	5.8*			4.1*	4.1*	10.8	
-4.5	38.2*	38.2*	21.5	24.3*	14.0	17.5*	9.8	12.4*	7.3	7.4*					3.2*	3.2*	9.8	
-6.0	33.3*	33.3*	20.5*	20.5*	12.9*	12.9*	6.6*	6.6*							4.7*	4.7*	7.9	
LC-V	12.0				10.7*	10.7*									7.2*	7.2*	6.7	
	10.5				10.7*	10.7*									6.0*	6.0*	8.6	
	9.0				10.3*	10.3*			9.7*	9.7*					5.4*	5.4*	9.9	
	7.5				11.3*	11.3*			9.9	10.1*	7.3	7.8*			5.1*	5.1*	10.8	
	6.0			19.4*	19.4*	15.2*	15.2*	12.2*	12.2*	9.7	10.3*	7.5	8.9*			4.9*	4.9*	11.4
	4.5	18.0*	18.0*	21.5*	21.5*	16.2*	16.2*	12.1	12.7*	9.5	10.5*	7.4	8.9*			4.8*	4.8*	11.8
	3.0	19.9*	19.9*	20.7*	20.7*	15.7	16.8*	11.8	13.0*	9.3	10.6*	7.2	8.8*	5.0*	5.0*	4.9*	4.9*	12.0
	1.5	15.6*	15.6*	21.8*	21.8*	15.6	16.6*	11.7	12.9*	9.4	10.4*	7.0	8.7*			5.0*	5.0*	12.0
	0	18.6*	18.6*	23.1	23.2*	15.7	16.6*	11.8	12.8*	9.1	10.4*	6.7	8.8*			5.3*	5.3*	11.8
	-1.5	24.1*	24.1*	23.6	23.8*	15.8	16.9*	11.5	13.1*	8.6	10.8*	6.5	8.2*			5.1*	5.1*	11.4
-3.0	31.2*	31.2*	23.5	24.5*	15.3	17.5*	11.2	13.7*	8.2	10.2*	5.3*	5.3*			4.0*	4.0*	10.8	
-4.5	38.0*	38.0*	23.6	24.2*	15.3	17.4*	10.8	12.1*	6.9*	6.9*					3.3*	3.3*	9.8	
-6.0	32.5*	32.5*	19.7*	19.7*	12.2*	12.2*	5.7*	5.7*							4.9*	4.9*	7.9	
HD	12.0				10.5*	10.5*									7.3*	7.3*	6.7	
	10.5				10.7*	10.7*									6.0*	6.0*	8.6	
	9.0				10.3*	10.3*			9.5	9.6*					5.4*	5.4*	9.9	
	7.5				11.2*	11.2*			9.6	10.1*	7.0	7.6*			5.1*	5.1*	10.8	
	6.0			17.2*	17.2*	14.7*	14.7*	12.2*	12.2*	9.4	10.3*	7.1	8.9*			4.9*	4.9*	11.4
	4.5	18.5*	18.5*	21.5*	21.5*	16.0	16.2*	11.8	12.7*	9.2	10.5*	7.1	8.9*			4.8*	4.8*	11.8
	3.0	19.4*	19.4*	20.7*	20.7*	15.4	16.8*	11.5	13.0*	9.1	10.6*	6.9	8.8*	4.9*	4.9*	4.9*	4.9*	12.0
	1.5	15.6*	15.6*	21.7*	21.7*	15.2	16.6*	11.4	12.9*	9.2	10.4*	6.7	8.7*			5.0	5.0*	12.0
	0	18.3*	18.3*	22.6	23.2*	15.3	16.6*	11.6	12.8*	8.8	10.4*	6.4	8.8*			5.1	5.3*	11.8
	-1.5	23.7*	23.7*	23.1	23.8*	15.1	16.9*	11.1	13.0*	8.2	10.8*	6.1	8.3*			5.2*	5.2*	11.4
-3.0	30.7*	30.7*	22.5	24.5*	14.7	17.5*	10.7	13.7*	7.8	10.3*	5.7*	5.7*			4.1*	4.1*	10.8	
-4.5	38.2*	38.2*	22.5	24.3*	14.6	17.5*	10.3	12.3*	7.3*	7.3*					3.3*	3.3*	9.8	
-6.0	33.2*	33.2*	20.3*	20.3*	12.8*	12.8*	6.4*	6.4*							4.8*	4.8*	7.9	

 Height
  Can be slewed through 360°
  In longitudinal position of undercarriage
  Max. reach
 * Limited by hydr. capacity

The load values are quoted in tons (t) at stick end (without bucket), and may be swung 360° on firm and even ground. Adjacent values are valid for the undercarriage when in the longitudinal position. Capacities are valid for 600 mm wide track pads with adjusting cylinder in optimal position. Indicated loads are based on ISO 10567 standard and do not exceed 75% of tipping or 87% of hydraulic capacity (indicated via *). Without bucket cylinder, link and lever the lift capacities will increase by 825 kg. Lifting capacity of the excavator is limited by machine stability and hydraulic capacity.

According to European Standard, EN 474-5: In the European Union excavators have to be equipped with an overload warning device, a load diagram and automatic safety check valves on hoist cylinders and stick cylinder(s), when they are used for lifting operations which require the use of lifting accessories.

Lift Capacities

with Mono Boom 9.20 m, Counterweight 11.0 t and Track Pads 600 mm

Stick 2.90 m

Under-carriage	m	3.0 m		4.5 m		6.0 m		7.5 m		9.0 m		10.5 m		12.0 m		13.5 m		m			
LC	12.0									7.6*	7.6*							7.6*	7.6*	9.1	
	10.5									7.3*	7.3*							7.2	7.3*	10.3	
	9.0									8.6*	8.6*							6.1	7.0*	11.2	
	7.5								9.7*	9.7*	8.2*	8.2*	6.9	7.2*				5.5	6.8*	11.8	
	6.0								10.3	11.0*	8.1	8.9*	6.4	7.8*	5.2	7.2*		5.0	6.8*	12.2	
	4.5								9.5	12.1*	7.6	9.6*	6.1	8.2*	5.0	7.4*		4.8	7.0*	12.4	
	3.0								9.1	12.7*	7.3	10.2*	5.9	8.6*	4.9	7.6*		4.7	7.2*	12.3	
	1.5								8.9	12.9*	7.0	10.4*	5.8	8.8*	4.8	7.6*		4.8	7.5*	12.2	
	0								8.9	12.7*	7.0	10.5*	5.7	8.8*				5.0	7.6*	11.8	
	-1.5					9.7*	9.7*												5.4	7.7*	11.1
	-3.0					12.7	14.7*												6.2	7.7*	10.3
	-4.5			15.7*	15.7*	13.0	13.6*												7.5*	7.5*	9.0
-6.0			13.8*	13.8*	11.8*	11.8*												6.7*	6.7*	7.3	
-7.5					8.7*	8.7*															
-9.0																					
LC-V	12.0									7.5*	7.5*							7.6*	7.6*	9.1	
	10.5									7.4*	7.4*							7.3*	7.3*	10.3	
	9.0									8.7*	8.7*							6.7	7.0*	11.2	
	7.5									9.8*	9.8*	8.3*	8.3*	7.3	7.5*			6.0	6.8*	11.8	
	6.0									11.1*	11.1*	8.8	9.0*	7.1	7.9*	5.7	7.2*	5.6	6.9*	12.2	
	4.5									10.5	12.1*	8.3	9.7*	6.8	8.3*	5.6	7.4*	5.3	7.0*	12.4	
	3.0									10.1	12.8*	8.0	10.2*	6.5	8.6*	5.5	7.6*	5.2	7.3*	12.3	
	1.5									9.9	12.9*	7.8	10.5*	6.4	8.8*	5.4	7.6*	5.3	7.5*	12.2	
	0									9.9	12.7*	7.8	10.5*	6.4	8.8*			5.6	7.6*	11.8	
	-1.5					10.4*	10.4*												6.1	7.7*	11.1
	-3.0					15.6*	15.6*												7.0	7.7*	10.3
	-4.5			13.6*	13.6*	13.5*	13.5*												7.5*	7.5*	9.0
-6.0			13.6*	13.6*	11.6*	11.6*												6.6*	6.6*	7.3	
-7.5					8.4*	8.4*															
-9.0																					

Stick 3.80 m

Under-carriage	m	3.0 m		4.5 m		6.0 m		7.5 m		9.0 m		10.5 m		12.0 m		13.5 m		m		
LC	12.0																	5.5*	5.5*	10.2
	10.5																	5.1*	5.1*	11.3
	9.0																	4.9*	4.9*	12.1
	7.5									6.9*	6.9*	6.4*	6.4*					4.8*	4.8*	12.7
	6.0					10.9*	10.9*	8.8*	8.8*	7.6*	7.6*	6.8*	6.8*	5.4	6.4*			4.5	4.8*	13.0
	4.5									10.1*	10.1*	8.3	8.3*	6.5	7.3*	5.2	6.7*	4.2	5.1*	13.2
	3.0									9.9	11.3*	7.8	9.1*	6.2	7.8*	5.0	7.0*	4.3	4.9*	13.2
	1.5									9.3	12.2*	7.3	9.7*	5.9	8.2*	4.9	7.2*	4.2	5.1*	13.2
	0									7.4*	7.4*	9.0	12.7*	7.1	10.2*	5.7	8.5*	4.2	5.3*	13.0
	-1.5									12.1*	12.1*	8.8	12.8*	6.9	10.4*	5.6	8.7*	4.4	5.8*	12.7
	-3.0									12.3	15.6*	8.9	12.5*	6.9	10.3*	4.7	7.1*	4.7	6.4*	12.1
	-4.5		12.9*	12.9*	10.5*	10.5*	12.6	14.7*	9.0	11.9*	7.0	9.8*	5.7	8.1*				5.3	7.1*	11.3
-6.0		19.1*	19.1*	16.2*	16.2*	13.0	13.2*	9.3	10.8*	7.2	8.8*						6.3	7.1*	10.2	
-7.5				13.2*	13.2*	10.8*	10.8*	8.8*	8.8*								6.8*	6.8*	8.7	
-9.0																				
LC-V	12.0																	6.0*	6.0*	10.2
	10.5																	5.4*	5.4*	11.3
	9.0																	5.1*	5.1*	11.3
	7.5																	4.9*	4.9*	12.1
	6.0																	4.8*	4.8*	12.7
	4.5									11.1*	11.1*	8.9*	8.9*	7.0*	7.0*	6.0	6.4*	4.8*	4.8*	13.0
	3.0									10.2*	10.2*	8.4*	8.4*	7.2	7.3*	5.8	6.7*	4.8*	4.8*	13.0
	1.5									10.8	11.4*	8.5	9.1*	6.8	7.8*	5.6	7.0*	4.8	4.9*	13.2
	0									10.2	12.3*	8.1	9.8*	6.6	8.3*	5.4	7.2*	4.7	5.1*	13.2
	-1.5									7.8*	7.8*	9.9	12.7*	7.8	10.2*	6.4	8.6*	4.7	5.4*	13.0
	-3.0									12.6*	12.6*	9.8	12.8*	7.7	10.4*	6.3	8.7*	4.9	5.8*	12.7
	-4.5		13.4*	13.4*	17.4*	17.4*	13.7	15.6*	9.9	12.5*	7.7	10.3*	6.3	8.6*	5.3	7.1*		5.3	6.5*	12.1
-6.0		19.6*	19.6*	16.0*	16.0*	13.9	14.6*	10.0	11.9*	7.8	9.8*	6.4	8.0*				5.9	7.1*	11.3	
-7.5						13.0*	13.0*	10.3	10.7*	8.1	8.7*						7.1	7.1*	10.2	
-9.0						10.6*	10.6*	8.5*	8.5*								6.7*	6.7*	8.7	



















Height Can be slewed through 360° In longitudinal position of undercarriage Max. reach * Limited by hydr. capacity

The load values are quoted in tons (t) at stick end (without bucket), and may be swung 360° on firm and even ground. Adjacent values are valid for the undercarriage when in the longitudinal position. Capacities are valid for 600 mm wide track pads. Indicated loads are based on ISO 10567 standard and do not exceed 75% of tipping or 87% of hydraulic capacity (indicated via *). Without bucket cylinder, link and lever the lift capacities will increase by 825 kg/620 kg*. Lifting capacity of the excavator is limited by machine stability and hydraulic capacity.

According to European Standard, EN 474-5: In the European Union excavators have to be equipped with an overload warning device, a load diagram and automatic safety check valves on hoist cylinders and stick cylinder(s), when they are used for lifting operations which require the use of lifting accessories.

* just for stick 5.00 m

Stick 5.00 m

Under-carriage	3.0 m		4.5 m		6.0 m		7.5 m		9.0 m		10.5 m		12.0 m		13.5 m		Max. reach			
	m																			
LC	12.0																	4.1*	4.1*	10.4
	10.5																	3.8*	3.8*	11.6
	9.0																	3.6*	3.6*	12.6
	7.5																	3.5*	3.5*	13.3
	6.0																	3.5*	3.5*	13.8
	4.5					11.6*	11.6*	9.1*	9.1*	6.9*	6.9*	6.4*	6.4*	5.8*	5.8*	4.7	5.2*	3.4*	3.4*	14.2
	3.0					14.0*	14.0*	10.5*	10.5*	8.3	8.6*	6.6	6.6*	5.6	6.3*	4.4	6.2*	3.5*	3.5*	14.3
	1.5					11.9*	11.9*	10.0	11.7*	7.8	9.4*	6.3	8.0*	5.2	7.1*	4.3	6.4*	3.7*	3.7*	14.3
	0					11.6*	11.6*	9.4	12.5*	7.4	10.0*	6.0	8.5*	5.0	7.4*	4.2	6.6*	3.9*	3.9*	14.1
	-1.5			7.0*	7.0*	12.4	13.7*	9.2	13.0*	7.2	10.4*	5.9	8.8*	4.9	7.6*	4.1	6.5	4.0	4.1*	13.8
	-3.0	7.5*	7.5*	10.5*	10.5*	12.4	16.6*	9.1	13.0*	7.1	10.6*	5.8	8.9*	4.8	7.6*			4.2	4.6*	13.3
	-4.5	11.1*	11.1*	14.5*	14.5*	12.5	16.0*	9.1	12.7*	7.1	10.4*	5.8	8.7*	4.9	7.3*			4.6	5.2*	12.6
	-6.0	15.1*	15.1*	19.2*	19.2*	12.8	14.9*	9.3	12.0*	7.2	9.9*	5.9	8.1*					5.3	6.1*	11.6
	-7.5	20.1*	20.1*	16.8*	16.8*	13.2	13.3*	9.6	10.7*	7.5	8.7*							6.4	6.8*	10.3
	-9.0			13.2*	13.2*	10.5*	10.5*	8.3*	8.3*									6.6*	6.6*	8.6
LC-V	12.0																	4.1*	4.1*	10.4
	10.5																	3.8*	3.8*	11.6
	9.0																	3.6*	3.6*	12.6
	7.5																	3.5*	3.5*	13.3
	6.0																	3.5*	3.5*	13.8
	4.5					11.8*	11.8*	9.3*	9.3*	7.8*	7.8*	6.9*	6.9*	6.2	6.4*	5.0	6.0*	3.5*	3.5*	14.2
	3.0					14.2*	14.2*	10.6*	10.6*	8.7*	8.7*	7.3	7.5*	5.9	6.7*	4.9	6.2*	3.5*	3.5*	14.3
	1.5					11.8*	11.8*	10.9	11.8*	8.6	9.5*	6.9	8.0*	5.7	7.1*	4.8	6.4*	3.7*	3.7*	14.3
	0					11.7*	11.7*	10.4	12.6*	8.2	10.1*	6.7	8.5*	5.5	7.4*	4.7	6.6*	3.9*	3.9*	14.1
	-1.5			7.3*	7.3*	13.7	13.9*	10.1	13.0*	8.0	10.5*	6.5	8.8*	5.4	7.6*	4.6	6.5*	4.2*	4.2*	13.8
	-3.0	7.8*	7.8*	10.8*	10.8*	13.7	16.6*	10.0	13.0*	7.9	10.6*	6.4	8.9*	5.4	7.6*			4.6*	4.6*	13.3
	-4.5	11.4*	11.4*	14.9*	14.9*	13.9	15.9*	10.1	12.7*	7.9	10.4*	6.4	8.7*	5.4	7.3*			5.2	5.2*	12.6
	-6.0	15.5*	15.5*	19.0*	19.0*	14.2	14.8*	10.3	11.9*	8.0	9.8*	6.6	8.1*					5.9	6.2*	11.6
	-7.5	20.6*	20.6*	16.5*	16.5*	13.1*	13.1*	10.6*	10.6*	8.3	8.5*							6.8*	6.8*	10.3
	-9.0			12.8*	12.8*	10.2*	10.2*	8.0*	8.0*									6.5*	6.5*	8.6

 Height  Can be slewed through 360°  In longitudinal position of undercarriage  Max. reach * Limited by hydr. capacity

The load values are quoted in tons (t) at stick end (without bucket), and may be swung 360° on firm and even ground. Adjacent values are valid for the undercarriage when in the longitudinal position. Capacities are valid for 600 mm wide track pads. Indicated loads are based on ISO 10567 standard and do not exceed 75 % of tipping or 87 % of hydraulic capacity (indicated via *). Without bucket cylinder, link and lever the lift capacities will increase by 825 kg / 620 kg*. Lifting capacity of the excavator is limited by machine stability and hydraulic capacity.

According to European Standard, EN 474-5: In the European Union excavators have to be equipped with an overload warning device, a load diagram and automatic safety check valves on hoist cylinders and stick cylinder(s), when they are used for lifting operations which require the use of lifting accessories.

* just for stick 5.00 m

Available Buckets

Sticks 2.35 m / 2.90 m / 3.80 m

Mounting	Execution	Width (mm)	Capacity (m ³)	Teeth	Number of teeth	Weight (kg)
Direct	STD	1,350	1.65	Z 70	3	2,100
Direct	STD	1,550	2.00	Z 70	4	2,250
Direct	STD	1,750	2.35	Z 70	4	2,450
Direct	STD	1,950	2.70	Z 70	5	2,650
Direct	STD	1,950	3.00	Z 70	5	2,750
Direct	STD	2,100	3.30	Z 70	5	2,850
Direct	HD	1,350	1.65	Z 70	3	2,350
Direct	HD	1,550	2.00	Z 70	4	2,650
Direct	HD	1,750	2.35	Z 70	4	2,850
Direct	HD	1,950	2.70	Z 70	5	3,100
Direct	HD	1,950	3.00	Z 70	5	3,200
Direct	HD	1,950	3.30	Z 70	5	3,250
Direct	HD	2,100	3.50	Z 70	5	3,500
SWA 77	STD	1,350	1.65	Z 70	3	2,250
SWA 77	STD	1,550	2.00	Z 70	4	2,400
SWA 77	STD	1,750	2.35	Z 70	4	2,550
SWA 77	STD	1,950	2.70	Z 70	5	2,800
SWA 77	STD	1,950	3.00	Z 70	5	2,900
SWA 77	HD	1,350	1.65	Z 70	3	2,350
SWA 77	HD	1,550	2.00	Z 70	4	2,700
SWA 77	HD	1,750	2.35	Z 70	4	2,900
SWA 77	HD	1,950	2.70	Z 70	5	3,150

Stick 5.00 m (Kinematic R 946 Litronic)

Mounting	Execution	Width (mm)	Capacity (m ³)	Teeth	Number of teeth	Weight (kg)
Direct	STD	1,200	1.25	Z 50	4	1,300
Direct	STD	1,350	1.50	Z 50	4	1,400
Direct	STD	1,500	1.75	Z 50	4	1,500
Direct	STD	1,650	2.00	Z 50	4	1,600

Available Front Shovels

Mounting	Execution	Width (mm)	Capacity (m ³)	Teeth	Number of teeth	Weight (kg)
Direct	2	1,850	2.50	Z 70	5	4,700
Direct	3	1,850	2.50	Z 70	5	5,050
Direct	1	2,150	3.10	Z 70	5	5,150
Direct	2	2,150	3.10	Z 70	5	5,650
Direct	3	2,150	3.10	Z 70	5	6,050

Serial Equipment

Undercarriage

Lashing eyes
Sprocket with dirt ejector
Track and carrier rollers, sealed and lifetime-lubricated

Uppercarriage

Access platforms without protruding parts
Anti-skid surfaces
Automatic swing brake lock
Centralised lubrication system (automatic)
DEF tank filling indicator
DEF tank lockable access hatch
Engine hood with gas spring opening
Extended tool set including tool box
Handrails
Lockable fuel tank cap with padlock
Lockable service doors
Lockable storage box
Main switch, manual, lockable
Protection grid on radiator fan
Sound insulation
Swing-out radiators

Hydraulic System

Dedicated swing circuit
Filter with integrated fine filters
Hydraulic pressure measuring ports
Hydraulic tank shut-off valve
Magnetic rod
Pressure accumulator for controlled lowering of equipment with engine turned off

Engine

Air filter with automatic dust ejector
Automatic engine idling / speed increase, controlled via joystick sensors
Common-Rail injection system
Exhaust gas after-treatment system – DOC + DPF + SCR
Fixed geometry turbocharger
Fuel fine filter
Fuel pre-filter and water separator
Fuel priming pump
Intercooler
Power Pack EU Stage V
Stepless adjustable engine speed

Operator's Cab

7" multifunction colour touchscreen
Air conditioning, automatic, tri-zone, controlled via display
Armrests adjustable in width, height and inclination
Bottle holder
Cab air filters housing, accessible from ground level
Cab door sliding windows
Cigarette lighter
Coat hook
DEF consumption on touchscreen
DEF level on touchscreen
Electric socket in cabin (12 V)
Electric socket in cabin (24 V)
Emergency hammer
Engine oil level on touchscreen
Footrest
Fuel consumption on touchscreen
Fuel level on touchscreen
Interior lighting
Laminated right hand side window
LiDAT Plus (Liebherr data transfer system) *
Mechanical hour meters, visible from ground level
Movement priority between swing and boom, adjustable via touchscreen
Rain hood over front window opening
Rearview mirror
Rear view monitoring camera
Rear window emergency exit
Right hand side view monitoring camera
Roll-down sun blinds for windscreen and roof window
Rubber floor mat, fixed on floor and removable
Storage box
Storage nets
Storage spaces
Tilttable console left
Tinted windows
Visco-elastic damping
Windscreen wiper and washer
Work mode selector

Equipment

Anti-drift system boom cylinders
Anti-drift system stick cylinder
Boom cylinders regeneration
Pipe fracture safety valves for boom cylinders
Pivot points made of cast steel
SAE split flanges on high pressure lines
Stick cylinder regeneration

* optionally extendable after one year

Equipment Standard/Option

Undercarriage

Chain guide 3 pieces	•
Chain guide 4 pieces	+
Chain guide full length	+
Reinforced cover and base plate for centre section (HD and LC undercarriage)	+
Reinforced cover plate for centre section (LC-V undercarriage)	+
Screws protection for sideframe (LC-V undercarriage)	+
Special painting	+
Steps	•
Track pads triple grouser 600 mm	•
Track pads triple grouser 750/900 mm	+
Travel motor housing protection	+
Undercarriage HD	+
Undercarriage LC	+
Undercarriage LC-V	+

Upper-carriage

Air pre-filter with cyclonical dust trap	+
Boxing ring	+
Catwalk tiltable front left	+
Catwalks tiltable left and right	+
Counterweight heavy 11.0 t	+
Counterweight standard 9.0 t	•
Electric socket on uppercarriage (24 V)	+
Fixed cab riser 800 mm	+
Headlight on uppercarriage, lateral left, LED+, 1 piece	+1)
Headlight on uppercarriage, lateral right, LED+, 1 piece	+1)
Headlights on uppercarriage, front, LED, 2 pieces, protections included	•1)
Headlights on uppercarriage, front, LED+, 2 pieces, protections included	+1)
Headlights on uppercarriage, rear, LED+, 2 pieces	+1)
Lighting for tank area 1)	+
Lighting for uppercarriage access 1)	+
Pre-heating system for fuel	+
Radiator fine mesh protection grid	+
Reversible fan drive	+
Skyview 360°	+
Special painting	+
Swing ring and lubrication hoses protection	+
Tank refilling pump fuel	+
Uppercarriage bottom and side protection	+
Wiggins coupling for fuel	+

Hydraulic System

Bypass filter for hydraulic oil	+
Liebherr hydraulic oil	•
Liebherr hydraulic oil, adapted for extreme climate conditions	+
Liebherr hydraulic oil, biodegradable	+

Engine

Automatic engine shutdown after idling	+
Engine shut-down with overrun	+
Lighting for engine compartment 1)	+



Operator's Cab

2" seat belt with retractor	•
3" seat belt with retractor, orange colour	+
4-points seat belt	+
Acoustic travel alarm deactivatable	+
Auxiliary heater programmable	+
Bottom windscreen wiper	+
Cool box (12 V)	+
Dark tinted windows	+
Electrically adjustable and heated outside rear-view mirrors	+
Electronic immobiliser	+
Emergency stop in cab	+
FGPS front guard	+
FGPS front guard tiltable	+
Filter for hydraulic hammer return flow	+
Fire extinguisher	+
First-aid box	+
Follow me home	+
FOPS top guard	+
Handrests elevated for joysticks	+
Headlights on cab, front, LED, 2 pieces	• ¹⁾
Headlights on cab, front, LED+, 2 pieces	+ ¹⁾
Headlights on cab roof, front, LED+, 2 pieces	+ ¹⁾
High pressure circuit switchable on pedals or mini-joystick	+
High pressure circuit with Tool Control (20 attachment adjustments on display)	+
Impact resistant one-piece windscreen	+
Impact resistant roof window	+
Integral protection guard	+
Laminated roof window	•
Lighting for cabin access ¹⁾	+
Luminosity control (LED+ headlights) ¹⁾	+
Medium pressure circuit	+
Mini-joysticks proportional	+
Movement restriction for boom	+
Movement restriction for stick	+
Operator seat Comfort	•
Operator seat Premium	+
Overload warning system	+
Radio Comfort	+
Radio pre-installation	•
Retractable laminated two-piece windscreen	•
Roof sun shield	+
Roof window wiper	+
Rotating beacon on cabin, LED, 1 piece	+
Seat belt reminder	+
Shortcut button on joystick configurable	•
Special painting	+
Sun visor	+
Switch between high pressure and bucket cylinder controls	+
Windscreen bottom protection grid	+



Equipment

Boom bottom protection	+
Boom cylinder rods protection	+
Bucket cylinder rod protection	+
Centralised lubrication extended for connecting link	+
Floating boom	+
Headlights on boom, LED, 2 pieces, protections included	• ¹⁾
Headlights on boom, LED+, 2 pieces, protections included	+ ¹⁾
Mono boom 6.70 m	+
Mono boom 7.60 m	+
Mono boom 9.20 m	+
Mono boom straight 8.00 m	+
Pipe fracture safety valve for stick cylinder	+
Preparation for ripper tooth	+
Quick coupler SWA 77 hydraulic	+
Shovel boom 4.20 m	+
Shovel stick 2.78 m	+
Special painting	+
Stick 2.35 m	+
Stick 2.90 m	+
Stick 3.80 m	+
Stick 5.00 m	+
Stick bottom protection	+
Tool Management	+
Two-piece boom 7.90 m	+

• = Standard, + = Option

¹⁾ Equipment not individually available, but only as predefined lighting packages
Non-exhaustive list, please contact us for further information.

Options and / or special equipments, supplied by vendors other than Liebherr, are only to be installed with the knowledge and approval of Liebherr in order to retain warranty.

The Liebherr Group of Companies



Wide Product Range

The Liebherr Group is one of the largest construction equipment manufacturers in the world. Liebherr's high-value products and services enjoy a high reputation in many other fields. The wide range includes domestic appliances, aerospace and transportation systems, machine tools and maritime cranes.

Exceptional Customer Benefit

Every product line provides a complete range of models in many different versions. With both their technical excellence and acknowledged quality, Liebherr products offer a maximum of customer benefits in practical applications.

State-of-the-art Technology

To provide consistent, top quality products, Liebherr attaches great importance to each product area, its components and core technologies. Important modules and components are developed and manufactured in-house, for instance the entire drive and control technology for construction equipment.

Worldwide and Independent

Hans Liebherr founded the Liebherr family company in 1949. Since then, the family business has steadily grown to a group of more than 130 companies with more than 46,000 employees located on all continents. The corporate headquarters of the Group is Liebherr-International AG in Bulle, Switzerland. The Liebherr family is the sole owner of the company.

www.liebherr.com

Liebherr-France SAS

2 avenue Joseph Rey, B.P. 90287, FR-68005 Colmar Cedex
☎ +33 389 21 30 30, Fax +33 389 21 37 93
www.liebherr.com, E-Mail: info.lfr@liebherr.com
www.facebook.com/LiebherrConstruction